

Technical data sheet for

INDUCTION COOKTOP 450mm

- ROUND INDUCTION ZONE

IN511R3-B, IN511R3-LS, IN511R3-CB, IN511R5-B, IN511R5-LS, IN511R5-CB



IN511R5-LS

SPECIFICATIONS

Cooktop

1 x 3.5kW induction zone
or
1 x 5.0kW induction zone
Ø 270mm induction zones

Electrical requirements

IN511R3
3.5kW, 230-240V, 50/60Hz, 1P+N+E
15A / phase

IN511R5
5.0kW, 400-415V, 50/60Hz, 3P+E
7A / phase

Dimensions

Bench model
Width 450mm
Depth 812mm
Height 355mm
Incl. splashback 525mm
All models (excluding Bench model)
Width 450mm
Depth 812mm
Height 915mm
Incl. splashback 1085mm

Nett weight

88kg

Packing data

0.54m³, 130kg
Width 495mm
Depth 865mm
Height 1255mm

Options

Castors
Plinth mounting

IN511-B

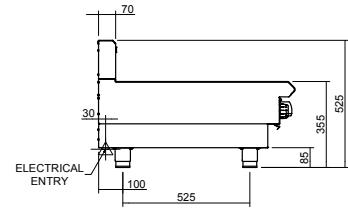
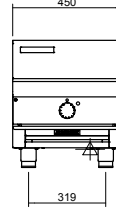

IN511-LS

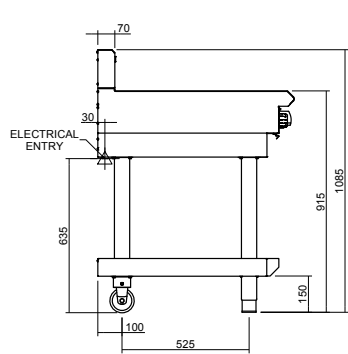
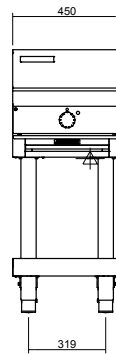

IN511-CB

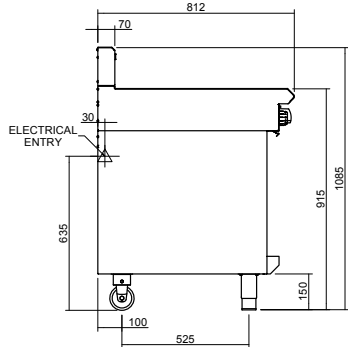
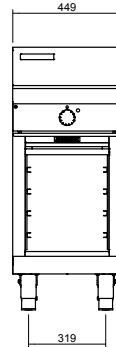

IN511R3 / IN511R5

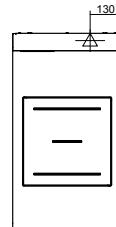

Australia moffat.com.au

New Zealand moffat.co.nz

In line with policy to continually develop and improve its products, Moffat Limited reserves the right to change specifications and design without notice.



ISO9001
Quality
Management
Standard

an Ali Group Company



The Spirit of Excellence