



EVOLUTIONSERIES

INSTALLATION AND OPERATION MANUAL

INDUCTION COOKTOP

IN511

IN512

IN514



Date Purchased	_____
Serial Number	_____
Dealer	_____

Service Provider	_____

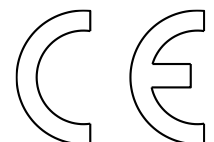

MANUFACTURED BY

Moffat Limited
Rolleston 7675
New Zealand

INTERNATIONAL CONTACTS

AUSTRALIA

Moffat Pty Limited
Web: www.moffat.com.au
E.Mail: vsales@moffat.com.au
Main Office: (tel) +61 (03) 9518 3888
(fax) +61 (03) 9518 3838
Service: (tel): 1800 622 216
Spares: (tel): 1800 337 963
Customer Service: (tel): 1800 335 315
(fax): 1800 350 281

CANADA

Serve Canada
Web: www.servecanada.com
E.Mail: info@servecanada.com
Sales: (tel): 800 551 8795 (Toll Free)
Service: (tel): 800 263 1455 (Toll Free)

NEW ZEALAND

Moffat Limited
Web: www.moffat.co.nz
E.Mail: sales@moffat.co.nz
Main Office: (tel): 0800 663328

UNITED KINGDOM

Blue Seal
Web: www.blue-seal.co.uk
E.Mail: sales@blue-seal.co.uk
Sales: (tel): +44 121 327 5575
(fax): +44 121 327 9711
Spares: (tel): +44 121 322 6640
(fax): +44 121 327 9201
Service: (tel): +44 121 322 6644
(fax): +44 121 327 6257

UNITED STATES

Moffat
Web: www.moffat.com
Sales: (tel): 1-800 551 8795 (Toll Free)
(tel): 336 661 1556
(fax): 336 661 9546
Service: (tel): 866 673 7937 (Toll Free)

REST OF WORLD

Moffat Limited
Web: www.moffat.co.nz
E.Mail: export@moffat.co.nz

The reproduction or copying of any part of this manual by any means whatsoever is strictly forbidden unless authorized previously in writing by the manufacturer.

In line with policy to continually develop and improve its products, Moffat Ltd. reserves the right to change the specifications and design without prior notice.

© Copyright Moffat Ltd. December 2022.

Blue Seal Induction Cooktops

IN511	450mm Single Zone Induction Cooktop.
IN512	450mm Dual Zone Induction Cooktop.
IN514	900mm Twin Dual & Quad Zone Induction Cooktop.

1. Introduction	2
Safety Notices Definitions / Safety symbols and Warnings on the Appliance	
Disclaimers	
Correct Disposal of this Product	
2. Specification	5
General	
Application	
Compliances	
Model Numbers Covered in this Specification	
Cooktops	
Woks	
Base options	
Induction Zone Types / Glass Identification	
Electrical Supply Requirements	
Installation Safety - Electrical	
Personal Protection	
Operating Conditions	
3. Dimensions	9
4. Installation	13
Installation Requirements	
Unpacking	
Location	
Clearances	
Assembly	
Electrical Connection	
Commissioning	
5. Operation.....	10
Operation Guide	
Description of Controls	
Operating the Cooktops	
6. Cleaning and Maintenance	12
General	
After Each Use	
Daily Cleaning	
Weekly Cleaning	
Monthly Filter Cleaning	
Periodic Maintenance	
7. Troubleshooting	14
Error Codes	
Generator Fault Messages (E1)	
8. Wiring Schematics.....	16
9. Replacement Parts List	18

1. Introduction

We are confident that you will be delighted with your BLUE SEAL INDUCTION COOKTOP, and it will become a most valued appliance in your commercial kitchen. To ensure you receive the utmost benefit from your new BLUE SEAL Appliance, there are two important things you can do.

Firstly:

Please read the instruction book carefully and follow the directions given. The time taken will be well spent.





Secondly:

If you are unsure of any aspect of the installation, instructions or performance of your appliance, contact your BLUE SEAL dealer promptly. In many cases a phone call could answer your question.

CE Only:

These instructions are only valid if the country code appears on the appliance. If the code does not appear on the appliance, refer to the supplier of this appliance to obtain the technical instructions for adapting the appliance to the conditions for use in that country.

Safety Notices Definitions / Safety symbols and Warnings on the Appliance

<p align="center">⚠ DANGER</p> <p>Indicates a hazardous situation that, if not avoided, will result in death or serious injury. This applies to the most extreme situations.</p>		<p>This symbol alerts you to a hazardous situation that WILL or COULD cause serious bodily harm or death. Be alert and implement relevant safety precautions.</p>
<p align="center">⚠ Warning</p> <p>Indicates a hazardous situation that, if not avoided, could result in death or serious injury.</p>		<p align="center">DANGER - HIGH VOLTAGE</p> <p>This dangerous voltage warning symbol indicates a risk of electric shock and hazards from dangerous voltage.</p>
<p align="center">⚠ CAUTION</p> <p>Indicates a hazardous situation that, if not avoided, could result in minor or moderate injury.</p>		<p align="center">Electromagnetic Field</p> <p>This symbol warns against non-ionizing electromagnetic radiation.</p>
<p align="center">Notice</p> <p>Indicates information considered important, and is used to address practices not related to physical injury. For example, messages relating to property damage.</p>		<p align="center">Equipotential bonding</p> <p>This symbol marks the terminal which has to be connected with the equipotential bonding system.</p>
<p align="center">NOTE</p> <p>Indicates useful, extra information about the action you are performing.</p>		<p align="center">⚠ Warning</p> <p align="center">RISK OF FIRE OR ELECTRIC SHOCK! DO NOT OPEN!</p> <p>To reduce the risk of fire or electric shock, do not remove or open cover. Refer servicing to qualified personnel.</p>

Disclaimers

⚠ DANGER

Disregarding any safety instructions may cause harm to people, the surroundings, and the equipment. The manufacturer and/or authorized representative are not responsible for any damages or personal injury caused by failure to observe any safety instructions. Risks involved when disregarding safety instructions include, but not limiting to:

- Death or injury caused by electric shock.
- Burn injury caused by contacting hot cooking surface, cookware, or oil and grease.
- Damage to the equipment caused by using unsuitable cookware.

⚠ DANGER

Do not install or operate equipment and/or accessories that have been misused, abused, neglected, damaged, or altered from that of original manufactured specifications.

⚠ DANGER

Contact the manufacturer if you intend to make any changes on the equipment. For safety reasons, always use genuine parts and accessories approved by the manufacturer or authorized representative. Refer to the warranty documents for your equipment.

⚠ DANGER

Owners and operators are cautioned that maintenance and repairs must be performed by an authorized service agent using only genuine replacement parts. The manufacturer will have no obligation with respect to any product that has been improperly installed, adjusted, operated or not maintained in accordance with national and local codes and/ or installation instructions provided with the product or any product that has its serial number defaced, obliterated or removed, and/or which has been modified or repaired using unauthorized parts or by unauthorized service agents.

⚠ DANGER

Improper installation, adjustment, alteration, service, or maintenance of this appliance or installation of a damaged appliance can result in DEATH, INJURY, EQUIPMENT DAMAGE, and void the warranty.

⚠ Warning

Do not store or use gasoline or other flammable vapors or liquids in the vicinity of this or any other appliance. Never use flammable oil soaked cloths or combustible cleaning solutions for cleaning.

⚠ Warning

This appliance is not intended for use by persons (including children) with reduced physical, sensory or mental capabilities, or lack of experience and knowledge, unless they have been given supervision concerning use of the appliance by a person responsible for their safety. Do not allow children to play with this appliance.

⚠ Warning

This product contains chemicals known to the State of California to cause cancer and/ or birth defects or other reproductive harm. Operation, installation, and servicing of this product could expose you to airborne particles of glass-wool or ceramic fibers, crystalline silica, and/or carbon monoxide. Inhalation of airborne particles of glass-wool or ceramic fibers is known to the State of California to cause cancer. Inhalation of carbon monoxide is known to the State of California to cause birth defects or other reproductive harm.

⚠ Warning

Authorized Service Representatives are obligated to follow industry standard safety procedures, including, but not limited to, local/ national regulations for disconnection / lock out / tag out procedures for all utilities including electric, gas, water and steam.

Notice

This appliance is not approved or authorized for home or residential use, but is intended for commercial applications only. The manufacturer and/or authorized representative will not provide service, warranty, maintenance or support of any kind other than in commercial applications.

Notice

Routine adjustments and maintenance procedures outlined in this manual are not covered by the warranty.

Note

Proper installation, care and maintenance are essential for maximum performance and trouble free operation of your equipment.

1. Introduction

Correct Disposal of this Product

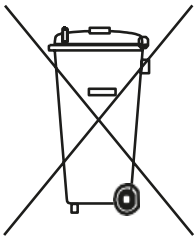

This marking shown on the product indicates that the product should not be disposed as household waste or regular commercial waste. Instead it shall be handed over to the applicable collection point for the recycling of electrical and electronic equipment. By ensuring this product is disposed correctly, you will help prevent potential harm to the environment or human health, which could otherwise be caused by inappropriate waste handling of this product.

For more detailed information regarding recycling of the product, please contact your local city office or your waste disposal service.

NOTE: The appliance is built with common electrical, electromechanical and electronic parts. No batteries are used.

NOTE: The owner and operator are responsible for the proper and safe disposal of the appliance.

Important
Additional Safety Notices are stated in the relevant sections throughout the manual.

General

A commercial heavy duty, high efficiency Induction Cooktop for modular kitchens, constructed with an easy clean stainless steel external finish. It has a high option Cooktop arrangement with either a 1, 2 or 4 Induction Heat Zone. It is available on Bench legs (80mm), Legstand, Cabinet Base or Cabinet base with door(s) industrial adjustable feet or with rear roller assemblies.

Built with a robust construction, our induction appliances are compact and powerful with the revolutionary INDUCS RTCSmp® Technology (Realtime Temperature Control System). The RTCSmp® Technology monitors continuously in real time, the energy supply, temperature of the cook zone and the state of the components such as the induction coil. This monitoring system ensures the most efficient energy transfer, as well as maximizes safety:

- Safety functions such as Pan Detection and Boil Dry Protection are therefore guaranteed.
- The appliance starts heating only when a pan is placed in the cooking zone.
- When a malfunction occurs, the integrated fault diagnostic system reports the malfunction instantly.

Application

Many applications throughout the day with your appliance are possible, such as cooking, warming up, keeping warm, and roasting of food:

- Thanks to RTCSmp temperature control happens instantly.
- With inductive energy transmission, your cookware can be heated very quickly.
- High power is possible for braising application and quick sauté.
- High power also means you can heat up a bigger pot quickly.

Round Zones are most efficient for larger pots as those used in bulk cooking or preparation.

Round = 1 pan per zone.

Full Area Zones are intended for small pots as they are used in a la carte area.

Full Area = multiple pans per zone.

Compliances



The induction technology complies to the latest norms.

Europe models

- EN 55014-1
- EN 55014-2
- EN 60529
- EN 62233 (EMC/EMV)
- EN 60335-1
- EN 60335-2-36
- EN 61000-3-11
- EN 61000-3-12

2. Specifications

Model Numbers Covered in this Specification

Cooktops

IN511R3	Induction Cooktop (450 wide)	1 x ø270 3.5kW	Round Induction Zone.
IN511R5	Induction Cooktop (450 wide)	1 x ø270 5.0kW	Round Induction Zone.
IN511F	Induction Cooktop (450 wide)	1 x 270 x 270 5.0kW	Full Area Induction Zones.
IN512R3	Induction Cooktop (450 wide)	2 x ø270 3.5kW	Round Induction Zones.
IN512R5	Induction Cooktop (450 wide)	2 x ø270 5.0kW	Round Induction Zones.
IN512F	Induction Cooktop (450 wide)	2 x ø270 5.0kW	Full Area Induction Zones.
IN514R3	Induction Cooktop (900 wide)	4 x ø270 3.5kW	Round Induction Zones.
IN514R3F	Induction Cooktop (900 wide)	2 x ø270 3.5kW	Round Induction Zones.
		2 x 270 x 270 5.0kW	Full Area Induction Zones.
IN514R5	Induction Cooktop (450 wide)	4 x ø270 5.0kW	Round Induction Zones.
IN514R5F	Induction Cooktop (900 wide)	2 x ø270 5.0kW	Round Induction Zones.
		2 x 270 x 270 5.0kW	Full Area Induction Zones.
IN514F	Induction Cooktop (450 wide)	4 x ø270 5.0kW	Full Area Induction Zones.

Base options

-B	Bench Model	
-L	Legstand Model	
-C	Cabinet Base	Optional GN 1/1 racking kit.
-D	Cabinet Base c/w Door(s)	Optional GN 1/1 racking kit.

Induction Zone Types - Glass Identification

Round R3 / R5 Zone Glass Identification

2 Short line Centre of Coil / Minimum pan diameter indicator
4 Long lines Extents of Coil / Maximum pan diameter



Full Area

4 Short lines Center of Coil / Minimum pan diameter indicator
2 Long lines Extents of Coil / Extents of cooking zone.

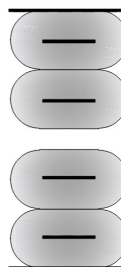

(Shaded areas shows induction coil under glass)

2. Specifications

Electrical Supply Requirements

Model	Power Supply			Total Power Input	Amps		
	Voltage	Type	Frequency		L1	L2	L3
IN511R3	230-240 Vac	1P+N+E	50 / 60 Hz	3.5 kW	15.2	n/a	n/a
IN511R5	400-415 Vac	3P+E	50 / 60 Hz	5.0 kW	7.2	7.2	7.2
IN511F	400-415 Vac	3P+E	50 / 60 Hz	5.0 kW	7.2	7.2	7.2
IN512R3	400-415 Vac	3P+E	50 / 60 Hz	7.0 kW	10.2	10.2	10.2
IN512R5	400-415 Vac	3P+E	50 / 60 Hz	10 kW	14.5	14.5	14.5
IN512F	400-415 Vac	3P+E	50 / 60 Hz	10 kW	14.5	14.5	14.5
IN514R3	400-415 Vac	3P+E	50 / 60 Hz	14 kW	21	21	21
IN514R3F	400-415 Vac	3P+E	50 / 60 Hz	17 kW	24.6	24.6	24.6
IN514R5	400-415 Vac	3P+E	50 / 60 Hz	20 kW	29	29	29
IN514R5F	400-415 Vac	3P+E	50 / 60 Hz	20 kW	29	29	29
IN514F	400-415 Vac	3P+E	50 / 60 Hz	20 kW	29	29	29

Installation Safety - Electrical

⚠ DANGER

Installation must be carried out by registered installation contractors only. The contractors are responsible for interpreting all instructions correctly and performing the installation in compliance with all applicable national and local regulations. The warning signs and serial plates on the equipment must strictly be followed.

⚠ DANGER

The device must be protected and connected with an all-pole circuit breaker which ensures complete separation under overvoltage category III.

⚠ Warning

This equipment is intended for indoor use only. Do not install or operate this equipment in outdoor areas.

⚠ Warning

The device must be operated with an all-pole circuit breaker or dis-connector of overvoltage category III.

⚠ Warning

CE Induction Appliance only: If ground fault current protective switches are used, they must be designed for a minimum fault current of 30mA, Type B or B+.

Notice

Ensure the supply voltage and the line current match the specifications given on the serial plate affixed to the appliance. Wrong voltage will damage the appliance. A stable power supply must be provided.

Notice

Always refer to the serial plate on the appliance to verify the electrical data. When the data listed on the serial plate is different than that listed in this manual, contact the manufacturer or the authorized representative.

Notice

All cables must be routed, protected and tension free.

2. Specifications

Personal Protection

⚠ DANGER

All utilities (gas, electric, water and steam) must be OFF to all equipment and locked out of operation according to national/regional regulations, as well as company approved practices during installation, maintenance and servicing. Always allow appliance to cool.

⚠ DANGER

Use appropriate safety equipment during installation, maintenance and servicing.

⚠ DANGER

To avoid cardiac pacemaker malfunction, consult your physician or pacemaker manufacturer about effects of electromagnetic field on your pacemaker.

⚠ DANGER

Replace defective power cables immediately by an authorized service agency.

⚠ Warning

Markings and warning labels mounted directly on the equipment must be observed at all times and kept in a fully legible condition.

⚠ Warning

Risk of burns from high temperatures. You may get burnt if you touch any of the parts during operation. Surfaces close to the cooking area including side panels may get hot enough to burn skin. Use extreme caution to avoid coming in contact with hot surfaces or hot grease. Wear personal protective equipment.

Operating Conditions

For the appliance to function properly, the following conditions must be maintained.

Maximum Tolerance of the Nominal Supply Voltage	+6 /-10 %
Supply frequency	50/60 Hz
Minimal Diameter of Induction Pan	12 cm [5"]
Maximum Ambient temperature in operation	+5°C to +40°C [+41°F to +104°F]
Maximum Relative Humidity in operation	30% to 90%

Dimensions

IN511*-B

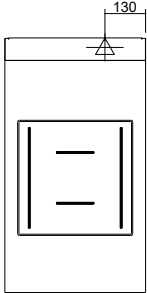
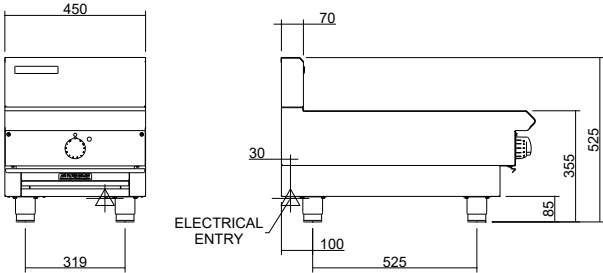

IN511F

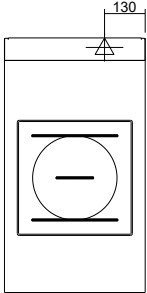

IN511R



IN511*-L

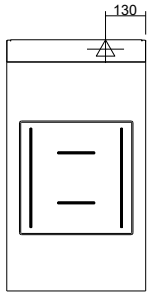
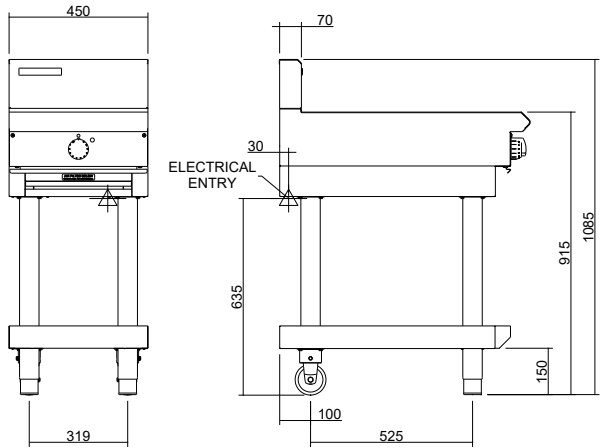

IN511F

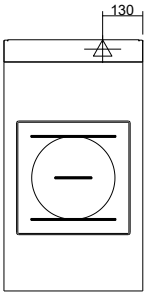

IN511R



3. Dimensions

Dimensions

IN512*-C

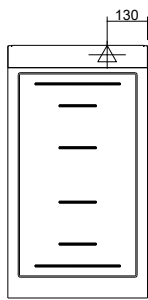
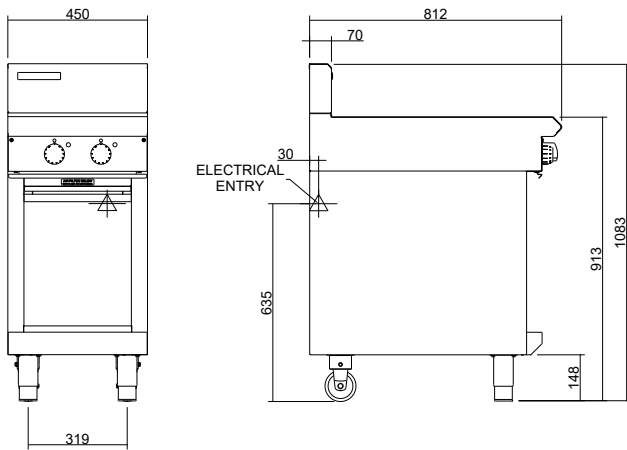

IN512F

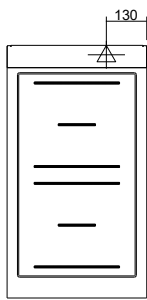

IN512R



IN512*-D

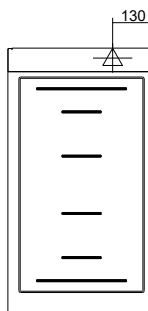
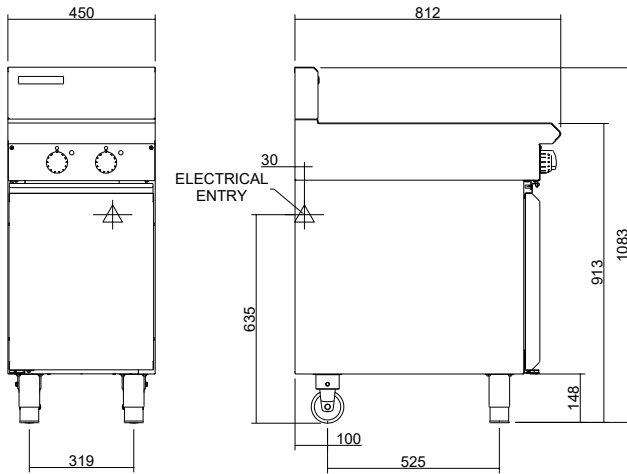

IN512F

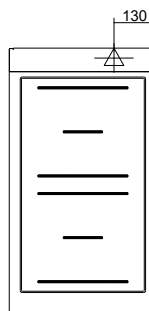

IN512R



Dimensions

IN514*-B

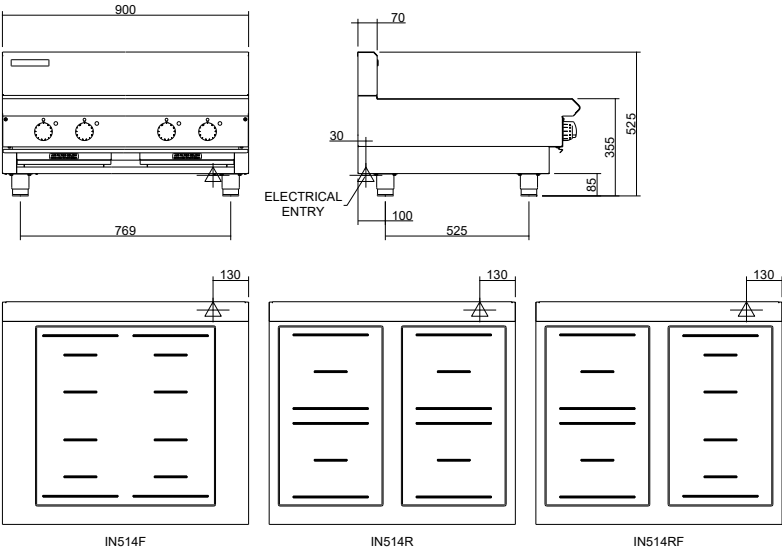

IN514*-L

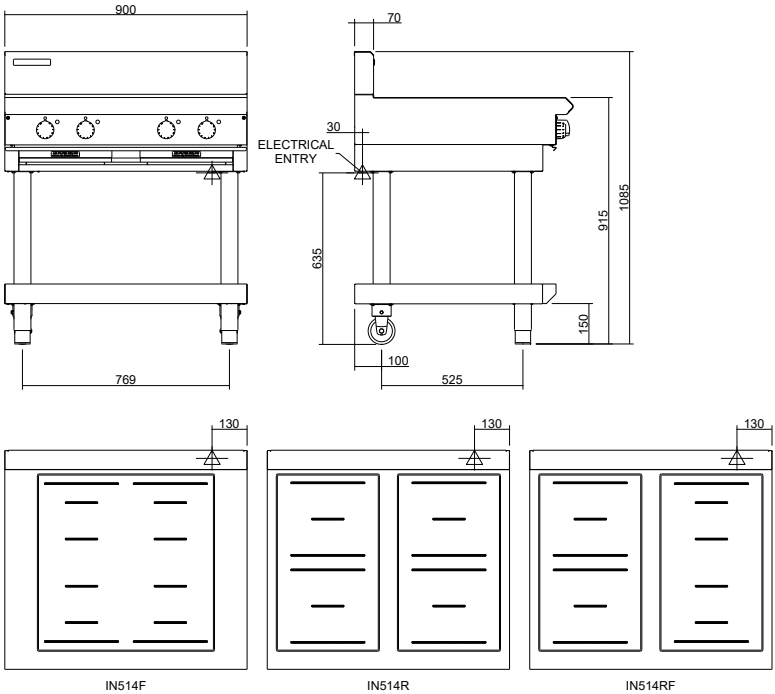

3. Dimensions

Dimensions

IN514*-C

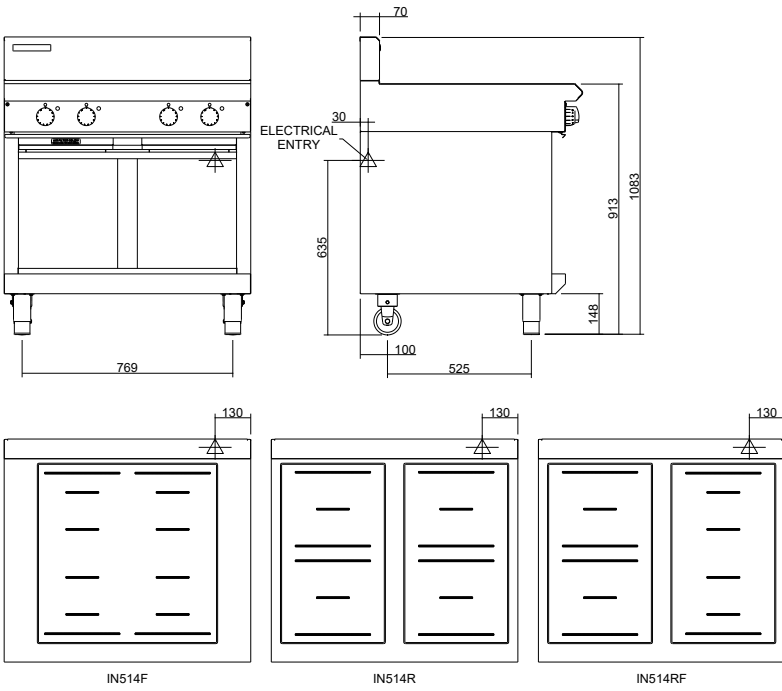

IN514*-D

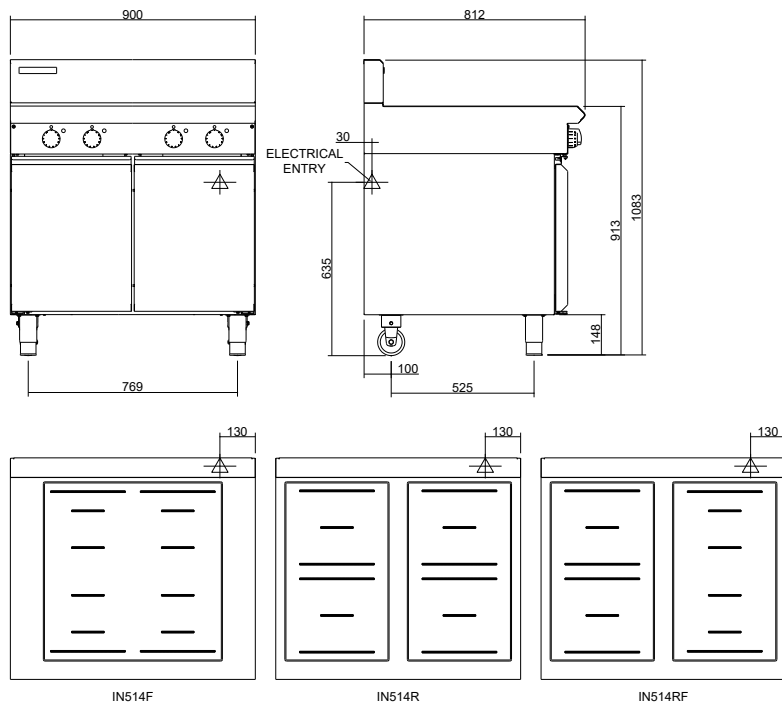

Installation Requirements

NOTE:

- It is most important that this Induction Cooktop is installed correctly and that operation is correct before use. Installation shall comply with local electrical and health and safety requirements.

Blue Seal Induction Cooktops are designed to provide years of satisfactory service, and correct installation is essential to achieve the best performance, efficiency and trouble-free operation.

This appliance must be installed in accordance with National installation codes and in addition, in accordance with relevant National / Local codes covering electrical and fire safety.

Australia / New Zealand AS/NZS 3000 - Wiring Rules.
United Kingdom: BS 7671 - Requirements for Electrical Installations.

Installations must be carried out by qualified persons only. Failure to install equipment to the relevant codes and manufacturer's specifications shown in this section will void the warranty.

Components having adjustments protected (e.g. paint sealed) by manufacturer, are only to be adjusted by an authorised service agent. They are not to be adjusted by the installation person.

Unpacking

- Remove all packaging and transit protection from the appliance including all protective plastic coating from the exterior stainless steel panels.
- Check equipment and parts for damage. Report any damage immediately to the carrier and distributor.
- Report any deficiencies to the distributor who supplied the appliance.
- Check that the available electrical supply is correct to that shown on the Rating Plate attached to the underside of the R/H side, front Induction Cooktop lower trim.

Location

1. Installation must include adequate clearance and ventilation.
2. Position the appliance in its approximate working position.
3. The legs must always be fitted. Ensure that the legs are securely attached.

Clearances

	Combustible Surface	Non Combustible Surface
Left / Right Hand Side	50mm	0mm
Rear	50mm	0mm

NOTE: Only non-combustible materials can be used in close proximity to this appliance.

4. Installation

Assembly

Bench Mount (B) Models

1. Check that all the feet are fitted and adjust to make the hob steady and level.

Optional Accessories (Refer to Replacement Parts List)

- Plinth Kit. For installation details, refer to the instructions supplied with each kit.

Leg Stand (LS) Models Only

1. Lower the appliance onto its rear face.
2. Attach the four Cooktop legs to the leg mount points on the underside of the Cooktop unit.
3. Secure each leg hand tight.
4. Align the 4 round holes in the corners of the base tray with the 4 Cooktop legs already fitted. (Ensure that the base tray is orientated with the sloping edge of the base tray facing the front of the appliance).
5. Slot the base tray onto the 4 Cooktop legs and push fully home.
6. Secure the base tray to the front cooktop legs by screwing the adjustable feet supplied, into the base of the front cooktop legs. Secure each adjustable foot, hand tight.
7. Fit the rear rollers to the rear leg ring plates and secure using the locating bolts supplied and tighten bolts using a 10mm spanner.
8. Lift the Cooktop back onto its legs.

NOTE: This appliance is fitted with adjustable feet / rear rollers to enable the appliance to be positioned securely and level. This should be carried out on completion of the electrical connection. Refer to the 'Electrical Connection' section.

All Other Models

All other models come pre-assembled.

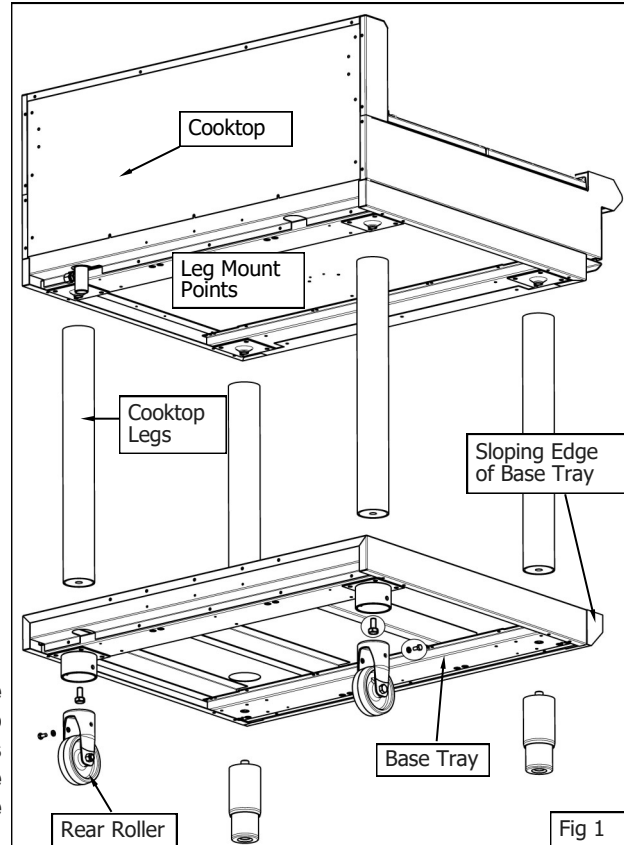

Electrical Connection

 WARNING

This appliance must be earthed. If the supply cord is damaged, it must be replaced by a suitably qualified person in order to avoid a hazard.

Notice

ALL ELECTRICAL CONNECTIONS MUST ONLY BE CARRIED OUT BY A QUALIFIED SERVICE PERSON.

Notice

- This appliance must be earthed.
- Fixed wiring installations must incorporate an all-pole disconnection switch.

Each appliance should be connected to an adequately protected power supply and isolation switch mounted adjacent to, but not behind the appliance. This switch must be clearly marked and readily accessible in case of fire.

1. Check that the electricity supply is correct as shown on the Rating Plate. Refer to the section 3 (Dimensions) for rating plate locations for the different model types.
2. The supply terminal connections are located at the rear of the the appliance. Refer to 'Electrical Connections' in the section 2 (Specifications) of the manual.
3. Bring the supply cable up through the compression type gland provided on the rear of the main electrical switchgear panel.
4. Connect the mains supply to L1, L2 and L3 terminal connections as required. Refer to the Electrical Supply Requirements in section 2 (Specifications).
5. Connect earth conductors to earth terminal.
6. For all connections ensure that conductors are secure and appropriately terminated.
7. Tighten the cable gland to secure against tension on the cable.
8. Correctly locate the appliance into its final operating position and using a spirit level, adjust the legs so that the appliance is level and at the correct height.
9. Connect the power supply to the appliance.
10. Check that the electrical supply is as shown in section 2 (Specifications).

4. Installation

Commissioning

	<ul style="list-style-type: none">• Read and understand all installation safety instructions regarding Personal Protection.• Observe also ALL operation safety requirements in section 3 (Operation).
---	--

1. Remove all objects from the glass top and examine the glass.

	<p>Caution</p> <p>Do not continue if the glass top is cracked, chipped or damaged in any other way. Contact an authorized service agency for assistance</p>
---	---

2. Connect the appliance to power supply.

Function Test

	<ul style="list-style-type: none">• Read and understand all installation safety instructions regarding Personal Protection.• Observe also ALL operation safety requirements in section 5 (Operation).
---	--

Testing procedure:

1. Examine the cookware for induction cooking:
 - Pans must be induction ready. See details in section 5 (Operation).
Minimum pan size: Pan must have bottom diameter larger than 12cm [5"].
Otherwise, the pan will not be heated. This is a safety feature.
The sensors does not detect pan smaller than this minimum size.
2. For each cooking zone turn the control to any power level setting.
3. Ensure the indicator (green) is flashing at a steady rate. This indicates the pan detection sensors are operational.
4. Put some water in an induction pan and place it in the center of the cooking zone. The indicator (green) should now show ia steady state. This indicates power is being transferred to the pan.
5. Remove the pan from the cooking zone and check the indicator returns to flashing at a steady rate.
6. Turn cooking zone off.
7. Repeat steps 2 - 6 for all cooking zones.

To test the efficiency of a pan for induction cooking, refer to section 7 (Troubleshooting).

If the appliance does not function as expected despite using quality induction pans, refer to section 7 (Troubleshooting).

If the unit does not operate correctly, remove from the electrical supply and contact a qualified service person. The supplier of the unit will be able to recommend a suitable person.

This manual must be kept by the owner for future reference and as a record of **Date of Purchase**, **Date of Installation** and **Serial Number** of Unit recorded and kept with this manual. These details can be found on the Rating Plate attached to the inner R/H side panel. Refer to the section 3 (Dimensions) for rating plate location.

Operation Safety - Disclaimer

 DANGER

The on-site supervisor is responsible to train operators for operating, maintaining and ensuring that operators are made aware of the inherent dangers of operating this equipment.

 DANGER

Risk of fire/shock/equipment failure. All minimum clearances must be maintained. Do not obstruct vents or openings.

 WARNING

This equipment is intended for indoor use only. Do not install or operate this equipment in outdoor areas.

Notice

The reliability of the appliance can only be guaranteed when it is used properly. The appliance must always be operated within the limits and/or the operating conditions provided in this manual.

Notice

Avoid dropping any hard objects onto the equipment. Damages to the heating surface will shorten the life cycle of the equipment or incur high service costs.

**Notice – Models with Glass-Top
Use Only Induction Suitable Cookware**

Use only induction suitable cookware with proper sizes and made of proper material. The induction suitable cookware must be in good condition without any uneven, arched or partially detached bottoms. Using unsuitable cookware can cause the appliance to fail prematurely, void your warranty, and incur high service costs.

5. Operation

Operational Safety - Personal Protection

Notice

Induction appliances are more powerful, heat up pans quicker, and cook food faster than conventional cooking equipment. Your induction appliance needs to be operated and looked after in a different way than other conventional equipment.
Do not operate the equipment without reading this manual and understanding all safety requirements.

⚠ DANGER

If any part of the appliance is cracked or broken, **turn off the appliance and immediately disconnect the appliance from supply.**

Only if it is possible and safe, disconnect the equipment from main power supply. Do not touch any parts inside the appliance.

Disconnect electric power at the main power disconnecter for all equipment being serviced.

Failure to disconnect the power at the main power supply could result in serious injury or death.

The knob DOES NOT disconnect incoming power.

Contact an authorized service agency for assistance.

⚠ DANGER

To avoid cardiac pacemaker malfunction, consult your physician or pacemaker manufacturer about effects of electromagnetic field on your pacemaker

⚠ DANGER

Never stand, sit, or lean on the equipment!

They are not designed to hold the weight of an adult, and may collapse or tip if misused in this manner.

⚠ Caution

Short Cook Time

Induction appliances cook food faster than conventional cooking equipment. To avoid overheating and burning, check the cooking process frequently. Never leave the appliance unattended during operation.

⚠ Caution

Metallic objects are heated up very quickly when placed on the induction cook zone during operation. To avoid injury,

DO NOT place any objects such as closed cans, aluminum objects (aluminum foils), cutlery, jewelry, or watches on the appliance.

DO NOT place any object such as paper, cardboard, or cloth on the cooking surface, because this creates a fire hazard.

DO NOT place credit cards, phone cards, tapes, or any objects that are sensitive to magnetism on the appliance.

DO NOT use the appliance for storage.

DO NOT place any paper products, cooking utensils, cutlery, plastic vessels or food on the appliance.

DO NOT place metallic objects such as kitchen utensils, cutlery etc. on the hob surface within the cooking zones since they could get hot.

⚠ Caution

Aluminum foil must not be used with induction appliances! Aluminum foil may ignite and cause a fire!

Notice

Do not use the cooktop for food preparation such as cutting and chopping.

⚠ WARNING

Risk of burns from high temperatures. You may get burnt if you touch any of the parts during operation. Surfaces close to the cooking area including side panels may get hot enough to burn skin. Use extreme caution to avoid coming in contact with hot surfaces or hot grease. Wear personal protective equipment.

⚠ WARNING

Take care when operating the appliance, as rings, watches and similar objects worn by the user could get hot when in close proximity to the hob surface.

⚠ WARNING

During operation, it is possible that the floor around the unit become slippery. Wear suitable footwear and clean the floor if necessary.

Operating the Cooktop

Blue Seal appliances have been designed to provide simplicity of operation. Improper operation is therefore almost impossible, however bad operational practices can reduce the life of the appliance and produce a poor quality product. To use this appliance correctly please read the following sections carefully.

Description of Controls

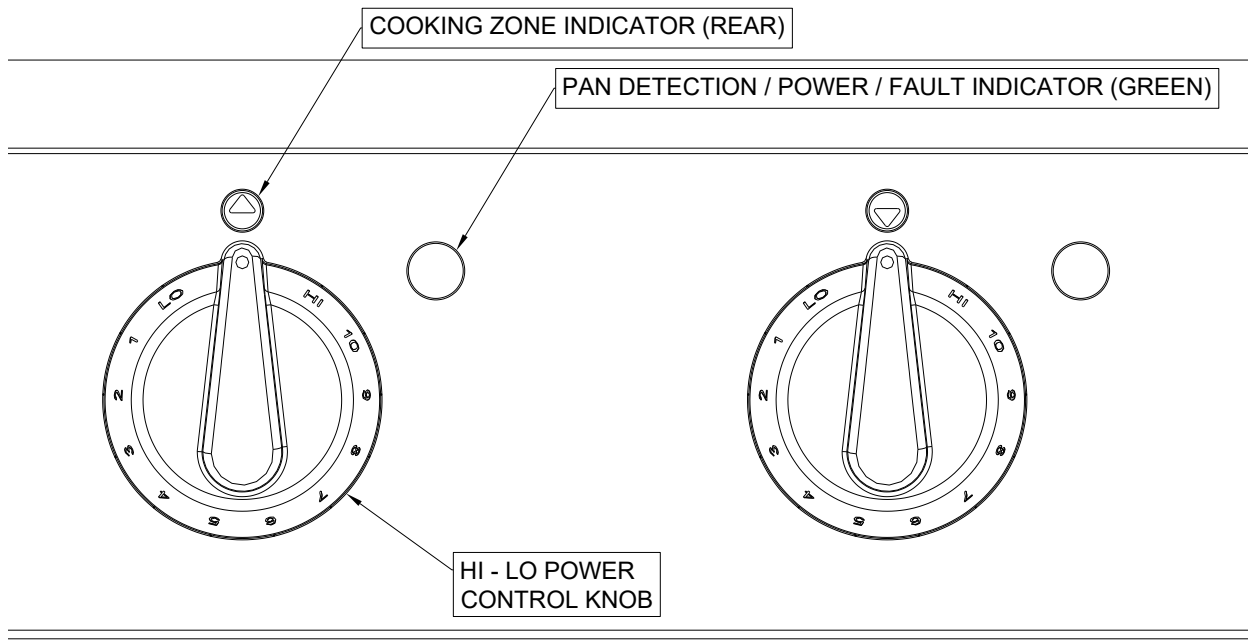

HI / LO Power Control Knob

Used to select the hob required and to adjust the temperature setting for individual cooking zones.

Pan Detection / Power / Fault Indicator (Green)

Illuminates and remains 'On' when a selected cooking zone is turned 'On' and has a pan on the cooking zone.

If the hob is turned 'On' without a pan on the cooking zone, the lamp will commence flashing at a steady rate until a pan is placed on the selected cooking zone.

Also used as the 'Fault Indicator' to display Generator Faults, refer to 'Error Code Pattern' in the 'Fault Finding' section.

5. Operation

Operating the Cooktop

Blue Seal appliances have been designed to provide simplicity of operation. Improper operation is therefore almost impossible, however bad operational practices can reduce the life of the appliance and produce a poor quality product. To use this appliance correctly please read the following sections carefully.

⚠ WARNING:

INDUCTION HEAT SOURCE - CARE MUST BE TAKEN TO ENSURE THAT THE SPLASHBACK AND SURROUNDING AREAS ARE KEPT FREE OF METALLIC OBJECTS.

The controls for the cooking zones may be set at any position between 'High' and 'Low' to provide the desired level of heating. An individual green neon for each hob, will glow when the hob is 'On' with a pan present and extinguish when the hob is turned 'Off'.

Start cooking at the highest setting, and change to a lower setting when desired temperature is reached.

1. Turn power 'On' at the mains power supply.
2. Place cooking pan onto the cooking zone to be used, ensuring that there is liquid in the pan.

⚠ WARNING:

DO NOT HEAT EMPTY PANS WITHOUT SUPERVISION. ALWAYS PLACE PANS IN THE CENTRE OF A COOKING ZONE. PANS SHOULD NOT BE HEATED UP TO MORE THAN 300°C (570°F).

3. Turn the control knob to the desired temperature. The 'Green' indicator lamp will illuminate and stay 'On'.

Notice

IF THE CONTROL KNOB IS TURNED 'ON' WITHOUT A PAN IN THE COOKING ZONE, THE GREEN INDICATOR LAMP WILL COMMENCE FLASHING AT A STEADY RATE UNTIL A PAN IS PLACED IN THE COOKING ZONE.

4. On completion of cooking, turn 'Off' the control knob and remove the pan, the green indicator light will extinguish.

Notice

IF A FAULT HAS BEEN DETECTED. THE GREEN INDICATOR LIGHT WILL COMMENCE FLASHING. REFER TO 'ERROR CODE PATTERN' IN THE SECTION 7 (TROUBLESHOOTING). DO NOT USE THE APPLIANCE UNTIL THE FAULT IS RECTIFIED.

Important Rules - Operation and Maintenance

Follow these simple rule to ensure reliable and repeatable performance of your induction equipment.

1. Keep the kitchen temperature below 40°C [104°C].

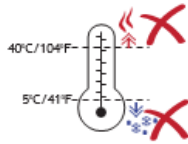
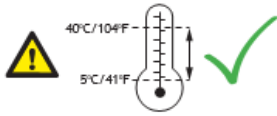

2. Clean the intake filter at least once a week or as often as required.



3. Do not use dented pans because it will cause damage to the electronics.



4. Use only pans that fit the glass markings. Do not use oversize pans.



5. Never pre-heat the pan. Place the pan on the cooking zone when you are ready to cook.



5. Operation

Proper Induction Cookware

Condition

Follow these simple rule to ensure reliable and repeatable performance of your induction equipment.

- Pans with layer separation (outward and inward bubbles), arching or partially detached bottoms must be replaced.
- When these pans are used, the sensors under the glass-top cannot detect the temperature correctly. These pans will overheat the sensors and eventually will damage the sensors and the generator. The image below, shows examples of good and bad pans in cross section.

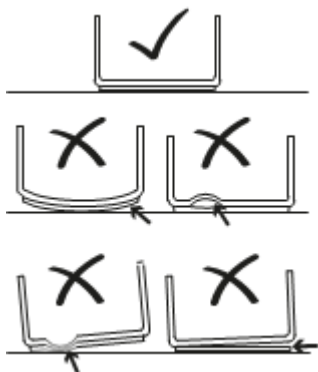

Material

- Use cookware made of conductive and magnetic materials. If the pan bottom attracts a magnet the pan is suitable for induction cooking. Look for cookware that is labeled "Suitable for Induction" or marked with an induction compatible symbol.



- Do not use pans made of aluminum, copper, glass or ceramics.
- Note - Steel inserts on bottom:
 - Cookware base inserted with areas of aluminum reduces the magnetic area for induction cooking. The appliance may supply less energy to the cookware or have difficulties in detecting the pan.

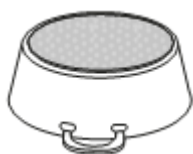

- Note - Non-magnetic cookware with a small magnetic base.
 - The exposed non-magnetic metal on the base may affect the induction field and subsequently, less energy may be supplied to the cookware.

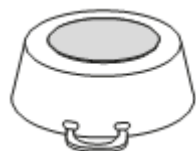

Boil Test

To test the efficiency of a pan for induction cooking, perform a boil test. See instructions in Section 7 (Troubleshooting).

Size of Pan

- Minimum Size: The bottom of pan must have a minimum diameter of 12cm [5"] (image below, shows minimum size against glass marking), Otherwise, the pan will not be heated. This is a safety feature such that the unit does not detect and heat small metal objects, such as jewelry. Note: For personal safety, never place any small metallic object on a cook zone.

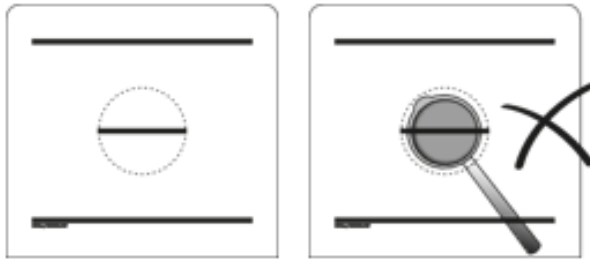

- Do not use oversized pan! The bottom of the pan must fit the glass. When a hot oversized pan covers the silicone seal underneath, the heat from the pan may dry out the silicone over time. When the silicone seal dries out and breaks, liquids can penetrate into the appliance and damage the electronics.

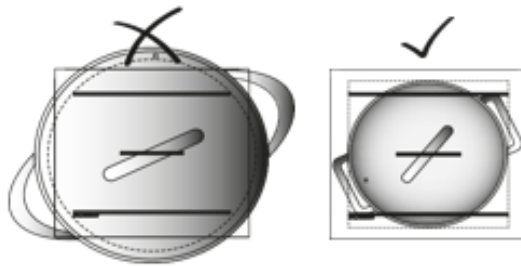

- Pan must fit the glass! The best pan to use is the one with a bottom that fits the coil.

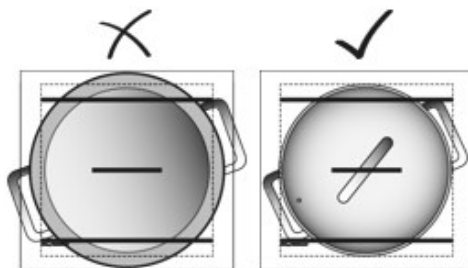

5. Operation

Placing Pan on a Cooking Zone

Each cook zone of our appliances is equipped with the latest RTCSmp® sensors. These sensors monitor temperature and cookware continuously in real time. To obtain optimal results from the sensors, you must always place pan in the center of the cook zone. Otherwise, the bottom of the pan is heated unequally and the food inside the pan may burn.

- For Round cooking zones place one pan per cook zone.

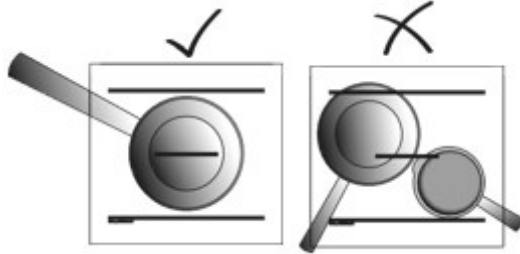

- For Full Area cooking zones you can use one pan or multiple pans per cook zone.

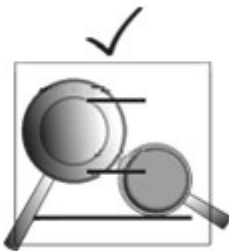

- Always place pan in the center of a cook zone.

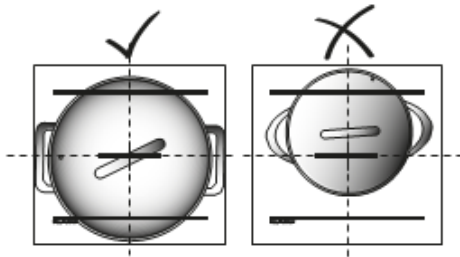

- Pan must not cover more than one cook zone on dual, twin dual or quad units.

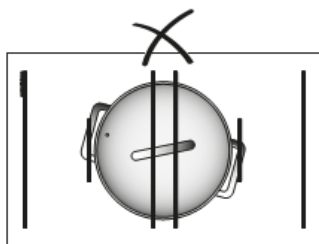

6. Cleaning and Maintenance

MAINTENANCE SAFETY - DISCLAIMER

⚠ DANGER

It is the responsibility of the equipment owner to perform a Personal Protective Equipment Hazard Assessment to ensure adequate protection during maintenance procedures.

⚠ Warning

A good maintenance of the appliance requires regular cleaning, care and servicing. The site supervisor and the operator must ensure all components relevant to safety are in perfect working order at all times.

Notice

Cleaning tools and supplies are not provided.

⚠ DANGER ELECTRICAL VOLTAGE

Do not open the appliance. Maintenance and servicing work other than cleaning as described in this manual must be done by an authorized service personnel.

⚠ DANGER

If any part of the appliance is cracked or broken, turn off the appliance and immediately disconnect the appliance from supply. Only if it is possible and safe, disconnect the equipment from main power supply. Do not touch any parts inside the appliance.

Disconnect electric power at the main power for all equipment being serviced.

Failure to disconnect the power at the main power supply could result in serious injury or death.

The power switch DOES NOT disconnect all incoming power.

Contact an authorized service agency for assistance.

MAINTENANCE SAFETY - CLEANING

⚠ Warning

Never use a high-pressure water jet for cleaning or hose down or flood interior or exterior of the equipment with water. Ensure that no liquid can enter into the equipment.

⚠ Warning

Allow heated equipment / glass surface to cool down before attempting to clean, service or move.

⚠ Warning

When cleaning the exterior, care should be taken to avoid front power switch and the electrical cords. Keep water and cleaning solutions away from these parts.

⚠ Caution

Do not use caustic cleaners on any part of the equipment. Use mild, non abrasive soaps or detergents, applied with a sponge or soft cloth.

⚠ Caution

Ensure to remove all residues of cleaning agents from the cooking surfaces. Use a clean moist cloth to wipe off any surfaces.

⚠ Caution

Using commercial cleaning fluids or chemicals: Read the directions for use and precautionary statements before use. Pay attention to the concentration of cleaner and the length of time the cleaner remains on the food contact surfaces or equipment surfaces.

Notice

Inspect and Clean Fresh Air Intake Filter. A dirty, blocked air intake filter blocks the air vent and can cause damages to the electronic components. Inspect, clean or replace the air intake filters at least once a week or as often as necessary.

⚠ Warning

Inspect Silicone Seal

When the silicone seal is broken, water penetration could cause the appliance to fail, and any malfunction could cause personal harm

6. Cleaning and Maintenance

MAINTENANCE SAFETY - PERSONAL PROTECTION

 DANGER

All utilities (gas, electric, water and steam) must be OFF to all equipment and locked out of operation according to national/regional regulations, as well as company approved practices during installation, maintenance and servicing. Always allow appliance to cool.

 DANGER

Use appropriate safety equipment during installation, maintenance and servicing.

 DANGER

To avoid cardiac pacemaker malfunction, consult your physician or pacemaker manufacturer about effects of electromagnetic field on your pacemaker.

 DANGER

Replace defective power cables immediately by an authorized service agency.

 Warning

Markings and warning labels mounted directly on the equipment must be observed at all times and kept in a fully legible condition.

 Warning

Risk of burns from high temperatures. You may get burnt if you touch any of the parts during operation. Surfaces close to the cooking area including side panels may get hot enough to burn skin. Use extreme caution to avoid coming in contact with hot surfaces or hot grease. Wear personal protective equipment.

 Warning

During operation or cleaning, it is possible for the floor to become slippery around the unit. Wear suitable footwear and clean the floor when needed.

6. Cleaning and Maintenance

Daily Cleaning and Maintenance

Clean the surface with a mild detergent and/or a food safe liquid cleaner which not penetrate the silicone seal around the glass.

GLASS CLEANING



NOTE: The cleaning of Ceran® glass is identical to cleaning other similar glass surfaces. You may use any regular glass cleaning products available from a hardware store.

You may use a razor blade scraper or a non scratching sponge to remove tough residues. When scraping, place your razor blade scraper at an angle of about 20° to 30° from the glass. Then wipe clean the glass with a cleaning product.

VISUAL INSPECTION OF SILICONE SEAL

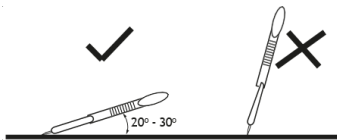

Inspect the silicone seal around the glass perimeter. Call for service immediately if you notice:

- Cracks on the silicone seal.
- The silicone seal comes away from the glass/ housing or moves when you press down on the seal.

Weekly Cleaning and Maintenance

Remove and clean air filter.

1. Pull the filter tray forward and remove the filter from the support tray.
2. Wash with warm soapy water or in dishwasher, rinse and allow to dry thoroughly

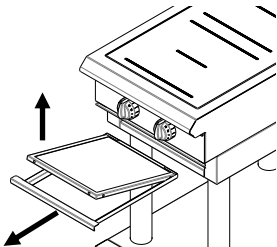

3. Re-fit filter into the filter tray and return to unit.

Note: Do not operate unit without air filter fitted.

Yearly Maintenance

Best Practice: Have the induction appliance examined once a year by an authorized technician.

General Maintenance Tips:

- Inspect all induction cookware to ensure proper condition.
- Have an authorized technician to inspect and ensure that:
- All ventilation fans are working properly.
- No grease built-up around the equipment and air filter.
- The silicone joints of the ceramic glass are in good condition.

DANGEROUS ELECTRICAL VOLTAGE

⚠ DANGER

If any part of the appliance is cracked or broken, turn off directly the appliance and Immediately disconnect the appliance from supply. Only if it is possible and safe, disconnect the equipment from main power supply. Do not touch any parts inside the appliance.

Disconnect electric power at the main power for all equipment being serviced.

Failure to disconnect the power at the main power supply could result in serious injury or death.

The power switch DOES NOT disconnect all incoming power.

Contact an authorized service agency for assistance.

⚠ DANGER

Do not open the appliance. Maintenance and servicing work other than cleaning as described in this manual must be done by an authorized service personnel.

⚠ Warning

Markings and warning labels mounted directly on the equipment must be observed at all times and kept in a fully legible condition.

Notice

If a problem arises during operation of your induction appliance, follow the Troubleshooting Charts before calling service. Routine adjustments and maintenance procedures are not covered by the warranty.

Common Problems

One or more of the following conditions may affect the function or cause the induction equipment to fail:

- Using unsuitable cookware such as non induction pans, oversized pans, or damaged pans.
- High ambient temperature.
- Inadequate ventilation causing hot air to re-enter through the air intake slots.
- Dirty air intake filter.
- Empty pan is left on the hob when the appliance is ON.

Symptoms

- When a malfunction occurs, the appliance may be in one of the following states:
- The appliance switches off immediately.
- The appliance continues to operate in a power reduction mode.
- The appliance continues to operate normally.

NOTE:

The cooling fan starts when the ambient temperature in the control area exceeds 55°C [130°F].

At heat sink temperature higher than 70°C [160°F], the controller automatically reduces power to keep the appliance in normal operating conditions.

Boil Test

To test the quality of a pan for induction cooking, perform a boil test.

(Test for 3.5kW or 5.0kW Induction Coil)

Perform a boil test to verify the performance of a pan for induction cooking.

Add one litre of cold water into the pan (optimal when use pan with bottom diameter of 24cm) and bring it to boil.

Compare the total boil time to the guideline below:

- 3.5kW Coil, approx. 140 seconds
- 5.0kW Coil, approx. 85 seconds

If time to boil exceeds the above guideline, then the pan is not suitable for achieving optimal efficiency.

Please contact your supplier to purchase suitable induction pans.

If the induction appliance does not function as expected despite using quality induction pans, refer to the troubleshooting charts.

Avoiding dangers in case of accidents or malfunctions

To avoid hazards in the event of a malfunction or accident related to the device, proceed as follows.

1. Disconnect the power supply from the circuit breaker provided for the device.
2. Disconnect the mains plug of the affected device to prevent it from being switched on again.

 **WARNING**

If the plug is not safely accessible, the device must be switched off at the main circuit breaker.

7. Troubleshooting

Troubleshooting Without Error Code

Pan does not heat up on cooking zone. Indicator is not illuminated	No power supply.	Check incoming power supply (Example, power cable plugged into the wall socket). Check kitchen main fuse box.
	Unit is turned off.	Turn control knob to an ON position.
	Defective unit	Only if possible and safe, disconnect the appliance from the power supply. Contact an authorized service agency. (1)
Pan does not heat up and LED indicator flashes at steady rate.	Pan is too small.	Use a suitable pan with bottom diameter larger than 12cm[5"].
	Pan is not placed in the center of cooking zone; pan is not detected by sensor. (2)	Move the pan to the center of the cooking zone.
	Unsuitable pan.	Select only induction ready cookware.
	Defective unit.	Only if possible and safe, disconnect the appliance from the power supply. Contact an authorized service agency. (1)
Poor heating, LED indicator is steady ON	Air cooling system is obstructed.	Verify that air vents are not obstructed. Ensure the fresh air filter is clean.
	Unsuitable pan.	Select various induction ready cookware for induction cooking. Then compare the results.
	Ambient temperature is too high. The cooling system is not able to keep the appliance in normal operating conditions.	Verify that no hot air is taken in by the fan. Reduce the ambient temperature. The intake air temperature must be lower than 40°C [104°F].
	One phase is missing.	Check incoming power supply (Example, power cable plugged into the wall socket). Check kitchen main fuse box.
	Defective unit.	Only if possible and safe, disconnect the appliance from the power supply. Contact an authorized service agency. (1)
Appliance does not react to control knob positions	Unit is turned off.	Turn control knob to an ON-position.
	Defective control knob.	Only if possible and safe, disconnect the appliance from the power supply. Contact an authorized service agency. (1)
Small metallic objects (e.g. spoon) are heated up in the cook zone.	Pan detection function is defective.	Only if possible and safe, disconnect the appliance from the power supply. Contact an authorized service agency. (1)

- (1) **⚠ DANGER** If the plug is not safely accessible, the device must be switched off at the main circuit breaker.

7. Troubleshooting

Troubleshooting With Error Code

Blink Code	Problem	Action
	Normal Operation	Normal Operation
1	Unsuitable induction cooking pan. Internal wiring/coil connection malfunction. (2)	Check pan material. Contact an authorized service agency.
2	Unsuitable induction cooking pan. Coil overcurrent. (2)	Check pan material. Contact an authorized service agency.
3	Air-cooling system obstructed. Fan malfunction. Heat sink overheated. (2)	Let appliance cool down. Verify that air vents are not obstructed. Check and clean air filter. Contact an authorized service agency.
4	Overheated cook zone. Overheated pan detected. Sensor failure.	Let appliance and/or pan cool down. Check pan material. Verify that air vents are not obstructed. Check and clean air filter. Contact an authorized service agency.
5	Potentiometer defective.	Contact an authorized service agency.
6	Ambient temperature too high (the cooling system is not able to keep the induction appliance in normal operating conditions). Internal component overheated. (2)	Let appliance cool down. Verify that air vents are not obstructed. Check and clean air filter. Verify that no hot air is taken in by the fan. Reduce the ambient temperature. The intake air temperature must be lower than 40°C [104°F]. Contact an authorized service agency.
7	Generator component failure. (2)	Contact an authorized service agency.
8	Sensor error from heat sink. Ambient temperature beyond normal operating range. (2)	Verify that air vents are not obstructed. Check and clean air filter. Reduce ambient temperature. Contact an authorized service agency.
10	Communication problem of the CAN interface	Contact an authorized service agency.

- (2) The appliance switches off immediately.

8. Wiring Schematic

Wiring Schematic - IN511 Induction Cooktop.

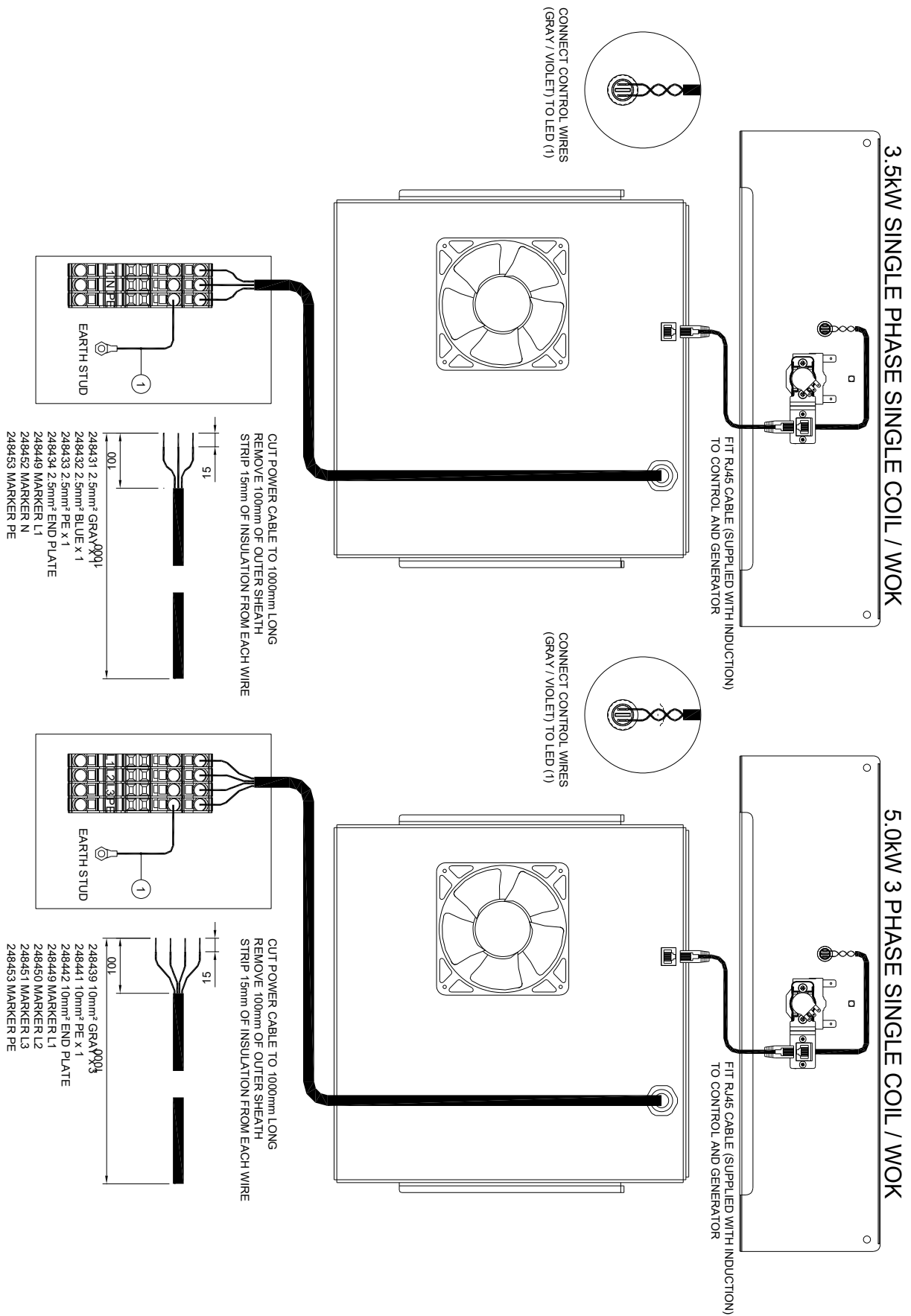

8. Wiring Schematic

Wiring Schematic - IN512 Induction Cooktop.

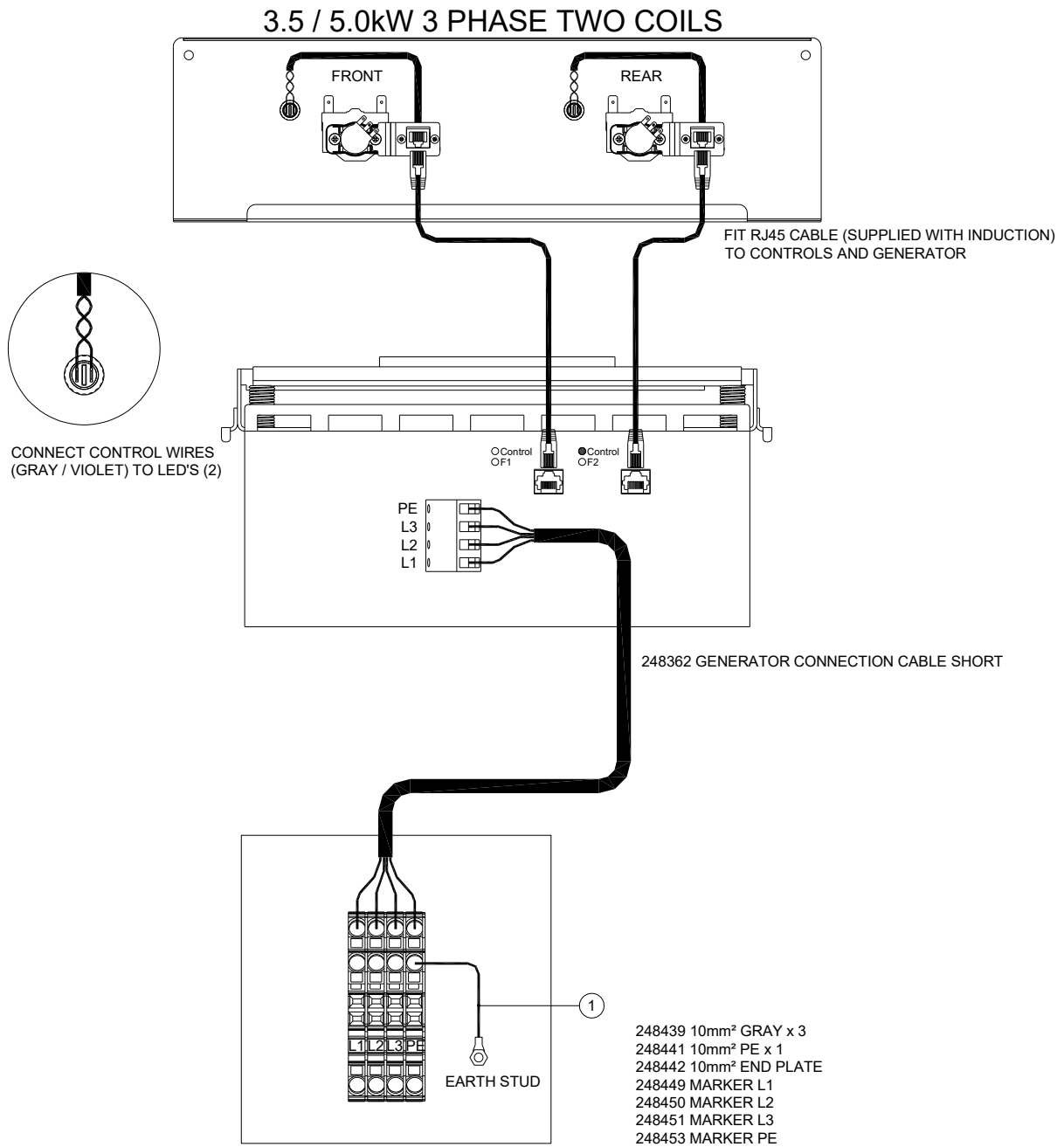

8. Wiring Schematic

Wiring Schematic - IN514 Induction Cooktop.

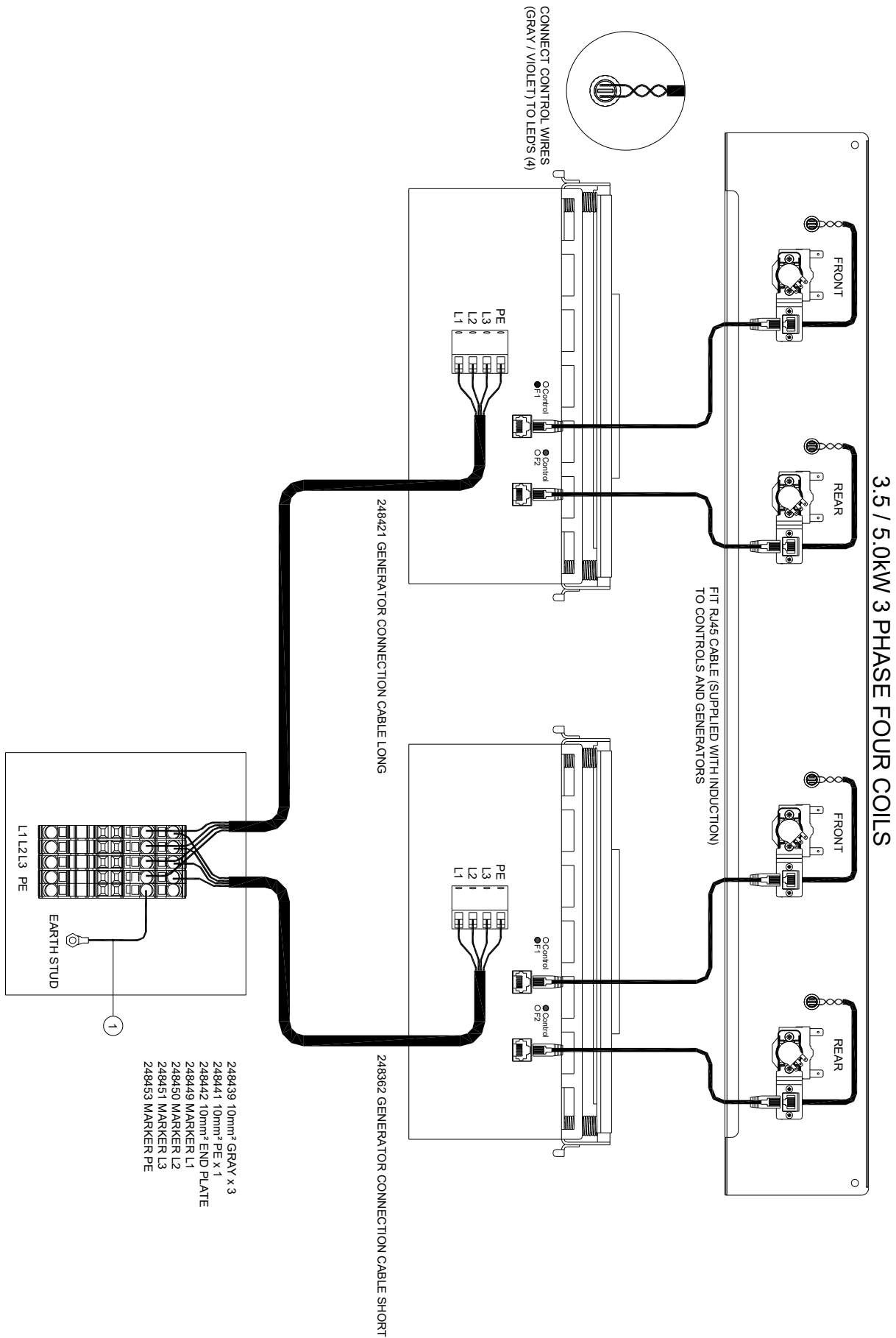

9. Replacement Parts List

Replacement Parts List

IMPORTANT:

Only genuine authorized replacement parts should be used for servicing and repair of this appliance. Instructions supplied with parts should be followed when replacing components.

For further information and servicing instructions, contact your nearest authorized service branch (contact details are as shown on reverse of front cover of this manual).

When ordering replacement parts, please quote part number and description as listed below. If the part required is not listed below, request the part by description and quote model number and serial number which is shown on the appliance Rating Plate.

247938	INDUCTION GLASS 360 X 360 1 ZONE ROUND
247939	INDUCTION GLASS 375 X 650 2 ZONE ROUND
248199	INDUCTION GLASS 360 X 360 1 ZONE FULL AREA
248200	INDUCTION GLASS 375 X 650 2 ZONE FULL AREA
247925	INDUCTION MODULE ROUND 1 X 3.5KW 230V 1PH
247926	INDUCTION MODULE ROUND 1 X 5KW 400V 3PH
247927	INDUCTION MODULE FULL AREA 1 X 5KW 400V 3PH
247928	INDUCTION MODULE ROUND 2 X 3.5KW 400V 3PH
247929	INDUCTION MODULE ROUND 2 X 5.0KW 400V 3PH
247930	INDUCTION MODULE FULL AREA 2 X 5KW 400V 3PH
244401	AIR FILTER SCREEN 450
248526	INDUCTION POTENTIOMETER CTRL TERMINATED
248234	INDICATOR LED 10MM GREEN 4.8QC 24V
248203	KNOB BLUE SEAL 6MM LO 1-10 HI INDUCTION
227855	LEG 80mm
227850	LEG 150mm (FLUSH STUD)
229674	REAR ROLLER ASSEMBLY
227856	MAGNET CATCH

