

# CD180

## RACK CONVEYOR OPERATOR MANUAL



**WASHTECH**<sup>®</sup>  
PROFESSIONAL WASH SYSTEMS

## Warnings



Before installation and commissioning, you must read the safety instructions and warnings carefully and all the warning labels attached to the equipment.

Equipment contains dangerous voltages and can be hazardous if installed or operated incorrectly. Non-compliance with warnings or failure to follow the instructions contained in this manual can result in loss of life, severe personal injury or serious damage to property.

Before installation or repair, you must read the instructions and warnings carefully and all the warning labels attached to the equipment.

All service/repair work must be carried out by qualified personnel only and ensure compliance with all local codes and standards including AS/NZS 3500.1.

## Important Information



Failure to comply (even partially) with the instructions given in this manual will invalidate the product warranty and relieves the manufacturer of any responsibility.

The alteration of machine operation, design or the replacement of parts not approved by the manufacturer may void warranties and approvals.

This machine is intended for commercial use only.

This machine is designed for the cleaning of fresh food waste from crockery, cutlery, containers and food preparation and manufacturing equipment. Consult the manufacturer regarding suitability of the machine for other applications. It is not a waste disposal unit, and it is essential that significant loose soil or waste is removed from washware by pre-rinsing or scraping, before it is placed in the machine.

The information contained in this document is checked, reviewed and updated regularly to ensure that it is accurate and relevant to the model described. However discrepancies and errors can occur. We welcome your feedback.

Document subject to change without prior notice.

Information supplied in this manual is copyright. No part of this work may be reproduced or copied in any form or by any means, electronic or mechanical without the express permission of Washtech.

# Contents

2. Warning
3. Contents
4. Safety Instructions
5. Installation Diagrams
7. Installation Instructions
9. Installation Checklist
10. Installation Troubleshooting
11. Operator Use Guide
12. Operator Care – Prewash Zone
13. Operator Care – Wash Zone
14. Operator Care – Curtains
15. Operator Troubleshooting
16. Schematic Diagram
17. Accessories
18. Notes



# Safety Instructions

## Installation

- Use qualified, skilled personnel.
- Follow installation instructions.
- Connect to correct voltage and supply current.
- Provide fully accessible Electrical Isolation Switch & water supply valves.

## Training and Supervision

- Read and Understand the Operating instructions and train all staff.
- This appliance must not be operated by children or infirm persons.
- Machine panels must only be removed by suitably qualified and trained personnel – internal hazards include live electrics and very hot surfaces.
- No part of this appliance is not intended for use as a stepladder – do not stand on open door.

## Hot Surfaces

- Some surfaces may be hot or very hot.

## Chemicals

- Commercial dishwashing detergents are hazardous – handle with care.
- Read and follow the safety information found on the labels of detergent containers and Material Safety Data Sheets.
- Use protective eyewear and clothing if decanting containers.

## Hot Water

- Do not put hands in wash water which may be over 60°C and contain hazardous caustic detergent.
- Rinse water can be over 90°C.
- Door safety switches are designed for emergency use only.

## Cleaning

- Do not hose down the machine or splash water over the exterior.
- Watch for broken glass etc. when cleaning the inside of the machine.

## Warnings



Equipment contains dangerous voltages and can be hazardous if installed or operated incorrectly. Non-compliance with Warnings or failure to follow the instructions contained in this manual can result in loss of life, severe personal injury or serious damage to property.

Installation and servicing must be carried out by a suitably qualified person in compliance with all local codes and standards including AS/NZS 3500.1.

# Installation Diagram

## CD180R Installation

- Part #: CD180R
- Date: 22-05-2022
- Version: 3-A

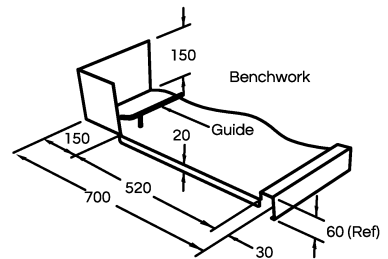
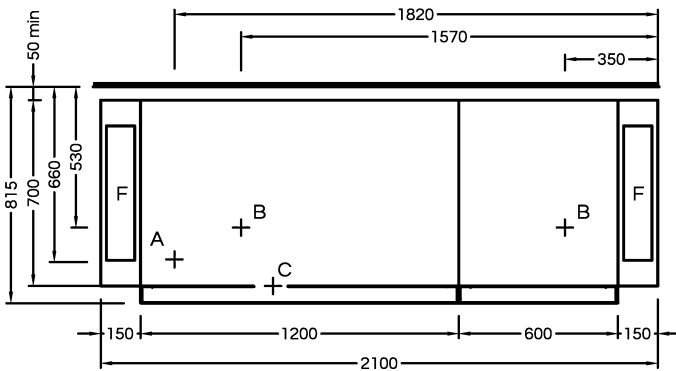
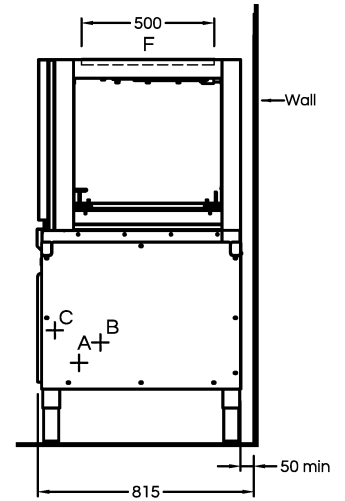
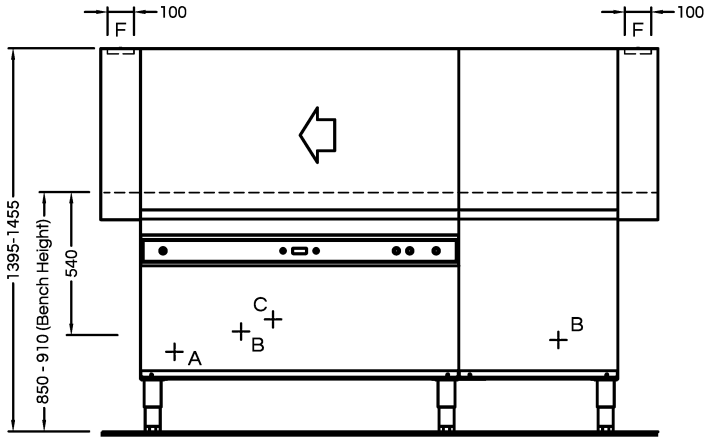

### Services

A	Hot water 65°C (DCV fitted)	200-350 kPa	3/4"
B	Waste - tank drainage point	2" BSP	50mm
C	Electrical connection	400-415V, 50Hz, 3P+N+E	28A <sub>3</sub>
F	Extraction - Consult with ventilation engineer.		10m /min (170l /sec)

Allow for steam. Total extraction rate typically required for duct connections

Note: Isolating switch must be within 1m of, and not directly behind the machine. Isolating water valve must be readily accessible

# Installation Diagram

## CD180L Installation

- Part #: CD180L
- Date: 22-05-2022
- Version: 3-A

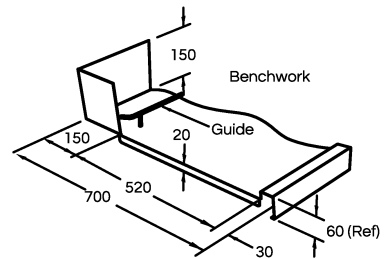
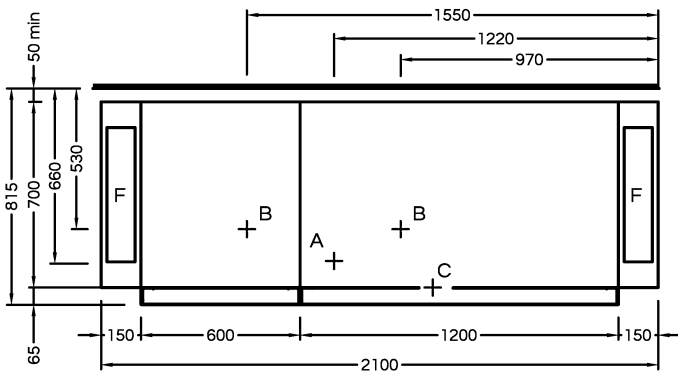
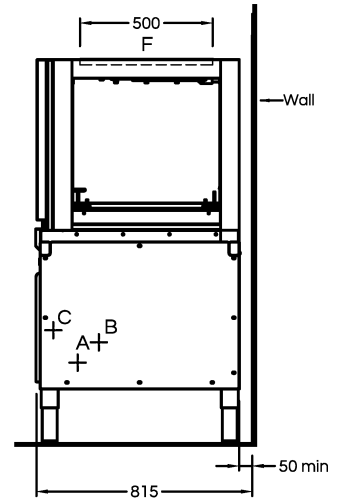
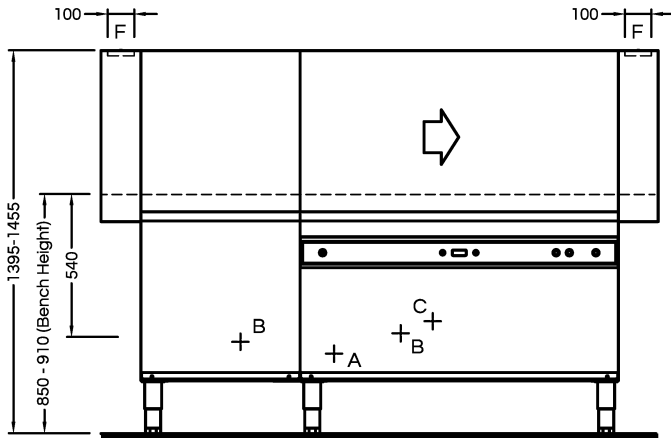

### Services

A	Hot water 65°C (DCV Fitted)	200-350 kPa	3/4"
B	Waste - tank drainage point	2" BSP	50mm
C	Electrical connection	400-415V, 50Hz, 3P+N+E	28A <sub>3</sub>
F	Extraction - Consult with ventilation engineer.		10m /min (170l /sec)

Allow for steam. Total extraction rate typically required for duct connections

Note: Isolating switch must be within 1m of, and not directly behind the machine. Isolating water valve must be readily accessible

# Installation Instructions

## Machine Positioning

- Unpack machine, check for damage and complete delivery.
- Install machine on sound waterproof self-draining floor and use adjustable feet to level machine.



NOTE: Failure to level the machine correctly may result in leaking during the cycle, overflowing from the door sill, poor hygiene through the wash tank not being able to drain correctly.

- Allow room for detergent to one side of machine or in adjacent cupboard. 20 litre container requires approximately 450H x 250W x 350D, but smaller containers are available from many suppliers.

## Ventilation

- 10 m<sup>3</sup>/min = 170 l/sec – refer installation diagram – extraction via connected ducts or overhead canopy.

## Inlet Water Operation

Incoming water should be within the following standard requirements:

- Temperature: 65 °C.
- Connection: 20 mm (3/4" BSP) male.



NOTE: Flush supply line before connection. Poor quality supply or excessive water hardness may affect performance or damage machine – filtration and/or softening is recommended.

- Flow rate: minimum 20 litres per minute.
- Water Consumption: 5 litres per minute.
- Pressure: between 200 and 350 kPa.



NOTE: This machine is not equipped with a rinse booster pump and relies on incoming water pressure to drive the rinse cycle.

NOTE: If above 350 kPa fit pressure limiter valve (LPV). Do not use small diameter plastic supply lines.

- Backflow prevention: Dual Check Valve (DCV) fitted standard.

## Water Quality Requirements

The incoming water should also be within the following parameters:



Hardness	ppm	pH
min	20	7
max	100	8

Ions	Cl <sup>-</sup>	SO <sub>4</sub>	Fe	Mn	Cu	Cl <sub>2</sub>
Max mg/L	100	400	0.1	0.5	0.05	0.1

NOTE: Levels above or below the stated requirements can be expected to increase component wear and reduce the expected useful life of the dishwasher. If in doubt, it is best to consult a water specialist and have the incoming water professionally tested and treated if necessary.

# Installation Instructions

## Power

- Electrical supply required is 3p/28A 415V 50Hz via switched outlet adjacent to machine.  
 NOTE: Equipment contains dangerous voltages and can be hazardous if installed or operated incorrectly. Non-compliance with warnings or failure to follow the instructions contained in this manual can result in loss of life, severe personal injury or serious damage to property.

## Chemical

- Detergent and rinse aid pumps are not supplied with the CD100. We recommend you consult your chemical supplier and/or a local chemical expert for their recommended detergent and Rinse Fluid injector pumps.

-  NOTE: Commercial detergents can be hazardous – read instructions, store safely and handle with care. Care needs to be taken when changing chemicals, ensuring that the detergent is not accidentally connected to the rinse fluid inlet line.  
NOTE: If uncertain, please consult a chemical specialist for assistance in selecting the right chemicals and calibrating machine settings to suit this along with your unique site conditions and requirements.

## Waste

- 40mm connection required to point B as specified on install diagram. An S-trap must be fitted on each of these points.

-  NOTE: Either copper or P.V.C. may be used for the waste connection – P.V.C. is more resistant to some harsh detergents. Some authorities however suggest that copper is required because the machine rinses at up to 90°C. It is important to note that rinse water mixes with the 65°C wash water before discharge and then flows into the trap where the water is further cooled before entering the drainage plumbing. We recommend consulting your local authority to ensure your site remains compliant.

## Installation Checklist

- Complete attached Installation Checklist to ensure machine is installed and running correctly, and operator is familiar with operating procedures.



# Installation Checklist

Check	Notes
<b>DELIVERY</b>	
SUPPLIED COMPLETE?	<input type="checkbox"/> CHECK THERE HAS NOT BEEN ANY TRANSIT DAMAGE
<b>POSITION</b>	
LEVEL AND STABLE?	<input type="checkbox"/> ON SOUND, WATERPROOF, SELF-DRAINING FLOOR
<b>WATER</b>	
ISOLATOR VALVE FITTED?	<input type="checkbox"/> ACCESSIBLE, ALL FITTINGS SOUND, AND NO LEAKS
TEMPERATURE CORRECT	<input type="checkbox"/> HOT WATER INLET 65 °C
PRESSURE CORRECT (200 – 350 kPa)?	<input type="checkbox"/> LIMITER FITTED IF ABOVE RANGE, RINSE PUMP IF BELOW
FLOW RATE CORRECT (> 20L per min)?	<input type="checkbox"/> RINSE PUMP FITTED IF BELOW REQUIREMENT
QUALITY WITHIN REQUIREMENTS?	<input type="checkbox"/> FILTER OR SOFTENER IN PLACE IF OUTSIDE REQUIREMENTS
<b>POWER</b>	
ISOLATING SWITCH	<input type="checkbox"/> FITTED, FUNCTIONAL AND ACCESSIBLE
CORRECT SUPPLY	<input type="checkbox"/> VOLTAGE, CURRENT, CIRCUIT BREAKER ALL CORRECT
<b>WASTE</b>	
CONNECTION TO 50mm PIPE?	<input type="checkbox"/> CORRECT CONNECTION TO PLUMBING
<b>CHEMICALS</b>	
	CHEMICAL NAME      CONTAINER      NO LEAKS      PRIMED      CALIBRATED
DETERGENT	_____ <input type="checkbox"/> <input type="checkbox"/> <input type="checkbox"/> <input type="checkbox"/>
RINSE FLUID	_____ <input type="checkbox"/> <input type="checkbox"/> <input type="checkbox"/> <input type="checkbox"/>
<b>MACHINE OPERATION</b>	
MACHINE RUNNING CORRECTLY?	<input type="checkbox"/> MULTIPLE CYCLES RUN, NO ISSUES
CHEMICAL DOSAGE CORRECT?	<input type="checkbox"/> CORRECTLY FLOWING INTO MACHINE, NO FOAMING
ALL OPERATIONS CORRECT?	<input type="checkbox"/> FILL LEVEL CORRECT, NO DRAINAGE ISSUES
<b>OPERATOR TRAINING</b>	
ENSURE THAT THE CUSTOMER HAS BEEN GIVEN THE OPERATION MANUAL AND WALL CHART, AND IS AWARE OF THE IMPORTANCE OF BOTH USING AND CLEANING THE MACHINE CORRECTLY	
START UP	<input type="checkbox"/>
PRE-RINSE AND RACKING	<input type="checkbox"/> BETTER TO RINSE PLATES THAN REMOVE WASTE FROM MACHINE
DRAINING THE MACHINE	<input type="checkbox"/> DRAIN THE MACHINE DAILY
SHUT-DOWN AND DAILY CLEANING	<input type="checkbox"/> CHECK WASH ELEMENTS HAVE COOLED BEFORE CLEANING
WEEKLY MAINTENANCE	<input type="checkbox"/> FULL MACHINE CLEAN INCLUDING WASH/RINSE ARMS
PLANNED SERVICNG	<input type="checkbox"/> IMPORTANCE OF HAVING MACHINE SERVICED REGULARLY

# Installation Troubleshooting

## Machine not starting or filling

- Ensure water supply to machine is turned on.
- Ensure power supply to machine is turned on.
- Check that the water inlet hose isn't twisted or kinked.

## Poor wash results

- Check that there are adequate pre-rinse processes in place.
- Ensure high quality non-foaming commercial dishwasher detergent has been connected at the correct dosage for your site, water quality and application. If uncertain, [consult a chemical specialist](#).
- Ensure that the wash temperature is between 60°C and 65°C.

## Chemical residue on items after the cycle

- Check water pressure, this is likely too low and below the minimum 200kPa required.
- Check that nothing is obstructing the wash & rinse arms.
- Check the rinse fluid dosage is not too high. If uncertain, please [consult a chemical specialist](#).

## Dishwasher is foaming

- Ensure high quality non-foaming commercial dishwasher detergent has been connected at the correct dosage for your site and application. If uncertain, please [consult a chemical specialist](#).
- Allow wash water to heat to at least 60 °C prior to starting the first cycle as some commercial dishwasher chemical will foam at low temperatures.
- Low water pressure can result in above average detergent concentrations. As low water pressure also impacts rinse results, we recommended this is solved by installing a rinse pump rather than compensating by reducing chemical dosages.

## Other equipment in the kitchen has needed filters or has scale

- Due to the high temperatures in dishwashers, scale will build up in the wash tank, on the arms and in the rinse tank. The incoming water should be treated. If uncertain, please [consult a water specialist](#).
- As with a Combi-Oven, high chloride levels will do irreversible damage to a number of the components inside a commercial dishwasher. The incoming water should be appropriately treated. If uncertain, please [consult a water specialist](#).

## Pawl drive not operating

- Clear the area around the limit switch on the roller table.
- Adjust the clutch tension of the Pawl Drive motor, the Pawl drive clutch tension can be tightened by turning the 2 nuts at the bottom of the pawl drive shaft clockwise or loosened by turning the 2 nuts anticlockwise.

(Note: the tension must be at a level where a person can grab the pawl drive with both hands and stop the pawl drive motion).

## Grinding noise escaping from the machine

- Wash pump rotation must be checked after installation to ensure correct direction (excessive noise and damage with incorrect direction). Change phase connection if required.

## Machine stops and refills during the commissioning stage

- Fit the curtains according to the Curtain labels on the front of the machine.
- Ensure the Scrap Trays are fitted in the Wash and Prewash Zones.

# Operator Use Guide



## START

- Turn on at wall.
- Prewash Zone:
  - Fit Wash Pump Filter (3)
  - Fit Drain Upstand(2).
  - Fit Scrap Tray (1).

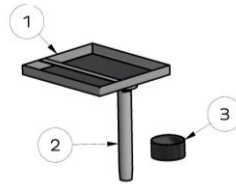

- Wash Zone:
  - Fit Wash Pump Filter (12).
  - Fit Drain Upstand (11) .
  - Fit Scrap Trays (10).

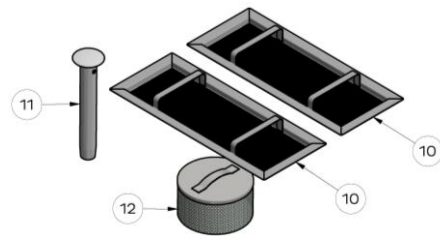

- Shut all doors and turn wall and Machine Power on.
- Machine begins filling. Full light glows amber when tanks are full.
- Ready light glows amber when the machine is up to required temperature.

## OPERATION

- Press Start button to operate machine.
- Cycle light glows green while machine operates.
- Stack one rack with items. Push the rack fully into the inlet zone of the machine. Ensure the rack is pushed fully into the inlet to engage pawl drive.
- Repeat for all consecutive racks

NOTE: Pumps and conveyor will stop operating if the machine is left idle for 2 minutes. To restart the pump and conveyor simply feed a new rack into the inlet of the machine.

## SHUT DOWN – END OF EACH DAY

- Press Stop button.
- Switch Power button off.
- Take out Drain Upstands to gravity drain the machine.
- Proceed with Operator Care cleaning instructions.

## SUGGESTED BEST PRACTICE

- |           |  |
|-----------|--|
| Pre-rinse | Scrape and/or rinse trays, plates & glasses in cool water  |
| Chemical  | Use a good quality non foaming commercial detergent and drying agent – do not use domestic detergents which will cause the wash tank to foam |

# Operator Care – Prewash Zone

## CD180 Prewash Zone

- Part #: CD180 Prewash Zone
- Date: 22/04/2022
- Version: 1-A

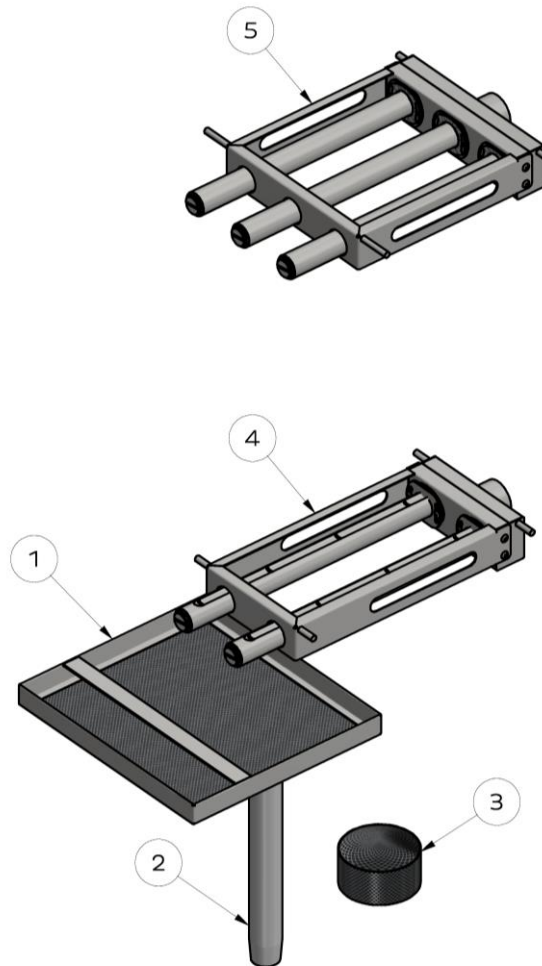

### Daily Cleaning

- Remove Scrap Tray (1) and clean with a brush and water to clear grid.
- Remove Prewash Pump Inlet Filter (3) and clean with a brush and water to clear grid.
- Return Drain Upstand (2), Prewash Pump Inlet Filter (3) and Scrap Tray (1) to the machine.

### Weekly Cleaning

- To be done in conjunction with Daily cleaning.
- Remove Lower Wash Arms (4) – lift up to unhook the arm and then withdraw.
- Remove Upper Wash Arms (5) – push the locking bar up and then withdraw the arm.
- Check to ensure arms are clear of obstructions. Remove end caps to clear if not.
- Flush Arms (4 & 5) with water. Use a toothpick or paper clip if necessary to clear jets.
- Return Prewash Pump Inlet Filter (3), Drain Upstand (2), Scrap Tray (1), Lower Wash Arms (4) and Upper Wash Arms (5) to the machine.

# Operator Care – Wash Zone

## CD120 Wash Zone

- Part #: CD120 Wash Zone
- Date: 22/04/2022
- Version: 1-A

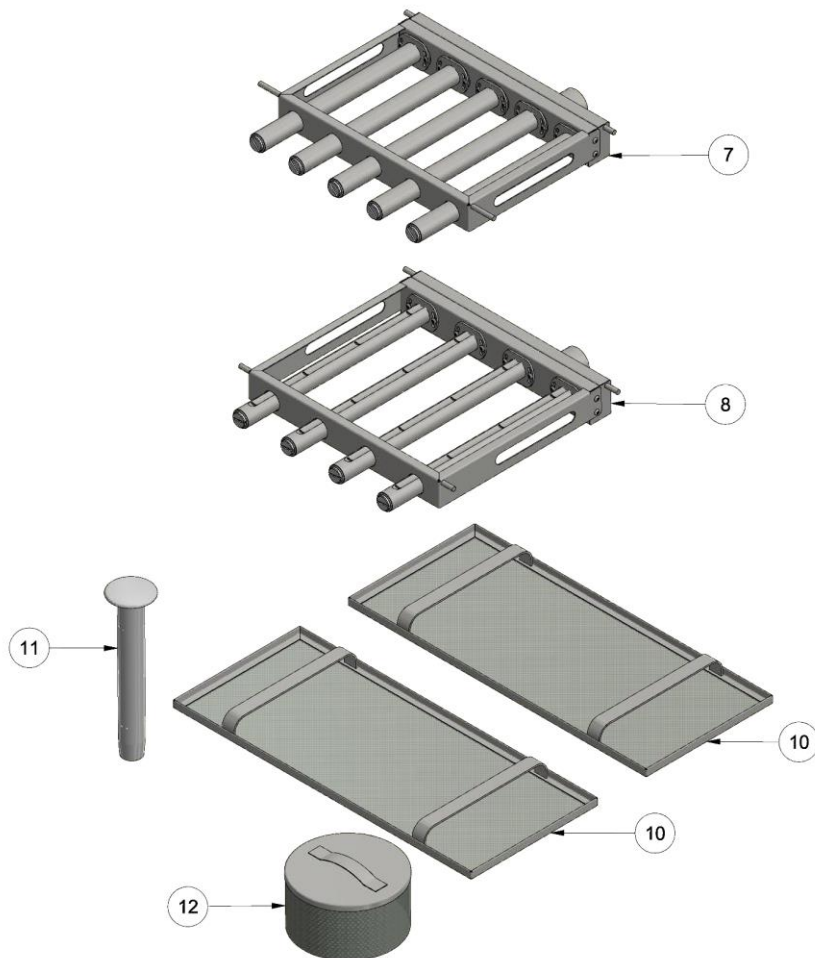

### Daily Cleaning

- Remove Scrap Trays (10) and clean with a brush and water to clear grid.
- Remove Wash Pump Inlet Filter (12) and clean with a brush and water to clear grid.
- Return Drain Upstand (11), Wash Pump Inlet Filter (12) and Scrap Trays (10) to the machine.

### Weekly Cleaning

- To be done in conjunction with Daily cleaning.
- Remove Lower Wash Arms (8) – lift up to unhook the arm and then withdraw.
- Remove Upper Wash Arms (7) – push the locking bar up and then withdraw.
- Check to ensure arms are clear of obstructions. Remove end caps to clear if not.
- Flush Arms (7 & 8) with water. Use a toothpick or paper clip if necessary to clear jets.
- Return the Wash Pump Inlet Filter (12), the Drain Plug (11), Scrap Trays (10), Lower Wash Arms (8) and Upper Wash Arms (7) to the machine.

# Operator Care – Curtains

## CD120/180 Curtains

- Part #: CD120180 CURTAINS
- Date: 08/07/2022
- Version: 1-A

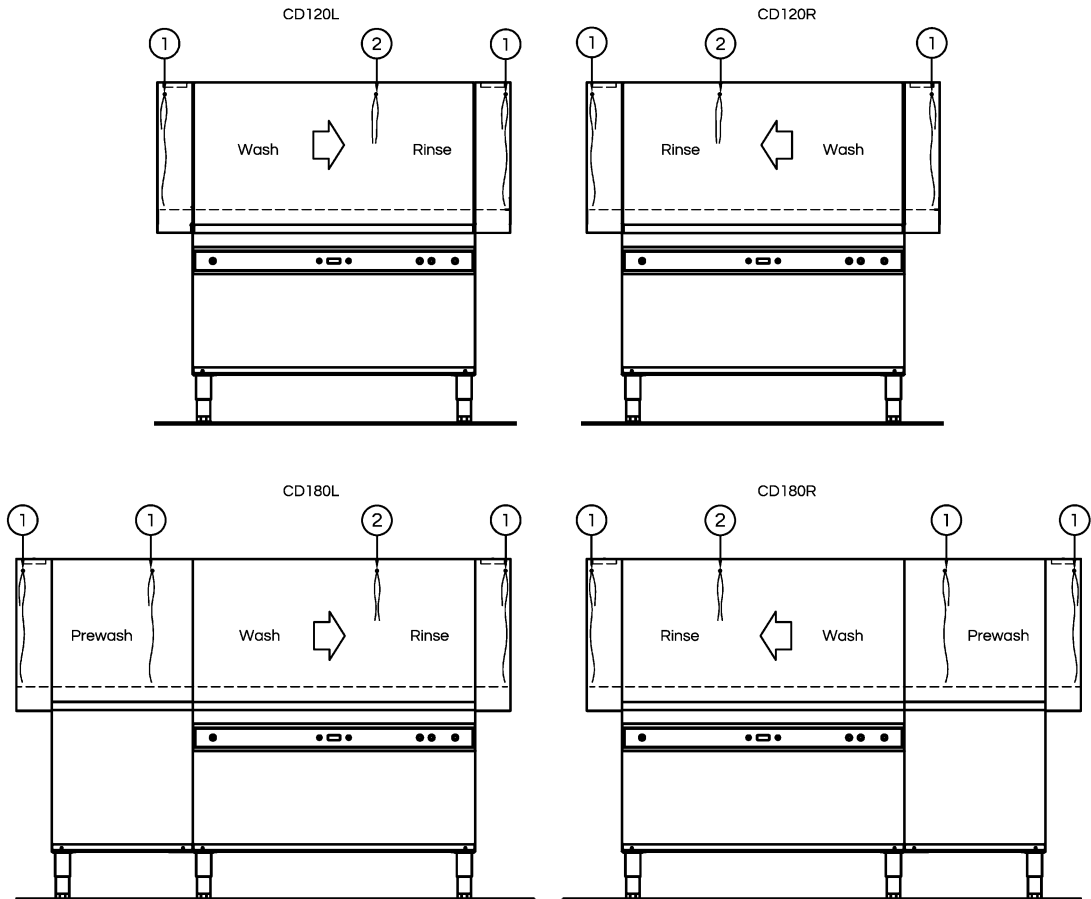

## Types Of Curtains

1. Long anti splash curtain 600 x 475 (Part number: 840 90011).
2. Medium anti splash curtain 600 x 210 (Part number 840 90012).

## Curtains & Extraction:

- Machines are shipped with curtains installed at the outside edges of the Vent Hoods which is the best arrangement for splash prevention.
- The curtains must be fitted with short side towards the INLET.
- Air flow from the hoods can be regulated with the adjusting T bar screws under the deflector baffles at the vents.
- When the machine is installed under a canopy the baffles can be opened up widely – drop baffle about 20mm.
- When extraction is fitted direct to the vent hoods the baffles may need to be more closed.
- Very strong extraction will result in significant drop of Wash Temperatures if not regulated.
- If extraction is very strong and can not be adequately restricted by the baffles then curtains must be moved to the inside edge of the hoods.

## Weekly Cleaning

- Remove curtains from hooks.
- Place each curtain into a dishrack and wash through the machine.

# Operator Troubleshooting

Issue	Cause										
	POOR PRE-SCRAPING	CARRY OVER OF SOAP FROM SINK	OVERLOADING RACKS	POOR MACHINE CARE	JETS BLOCKED OR ARMS OBSTRUCTED	CURTAINS NOT FITTED CORRECTLY	WATER SUPPLY PRESSURE LOW	POOR WATER QUALITY*	RINSE TEMPERATURE LOW <75 ° C	LIMIT SWITCH ACTIVATED	WASH ARM NOT FITTED PROPERLY
DISHES NOT CLEAN	●		●	■	■		■	■	■		
STAINING	●				●		■	■	■		
FOAMING		●		■							
PROTEIN BLOOM	■		■	●	■		■		●		
DIRTY MACHINE	●			●	■		■	■	■		
FOOD RESIDUE ON WARE	■		●	■	■		●	■	■		
FILM/SPOTS ON WARE			■	■	■		■	●	■		
DETERGENT RESIDUE					■	●	■				
GREASY FILM/NO FIZZ			■				●	■			
WET WASHWARE			●	■			■				
SCALE BUILD UP IN MACHINE				■				●			
FILTERS ON OTHER EQUIPMENT								●			
PAWL DRIVE NOT OPERATING										●	
CRASHING SOUND AGAINST DOOR											●
MACHINE STOPS & REFILLS CONSTANTLY							●				

● Likely cause      ■ Possible cause

\* For issues that are likely due to poor water quality (scale building up, filters being required on other kitchen equipment etc.), we recommend you consult a local water specialist prior to calling in a dishwasher technician.

**IF PROBLEMS PERSIST CONTACT MOFFAT SERVICE ON 1300 264 217**

# Schematic Diagram

## CD180 Schematic Diagram

- Part #: 260104
- Date: 11-05-2022
- Version: 1-A

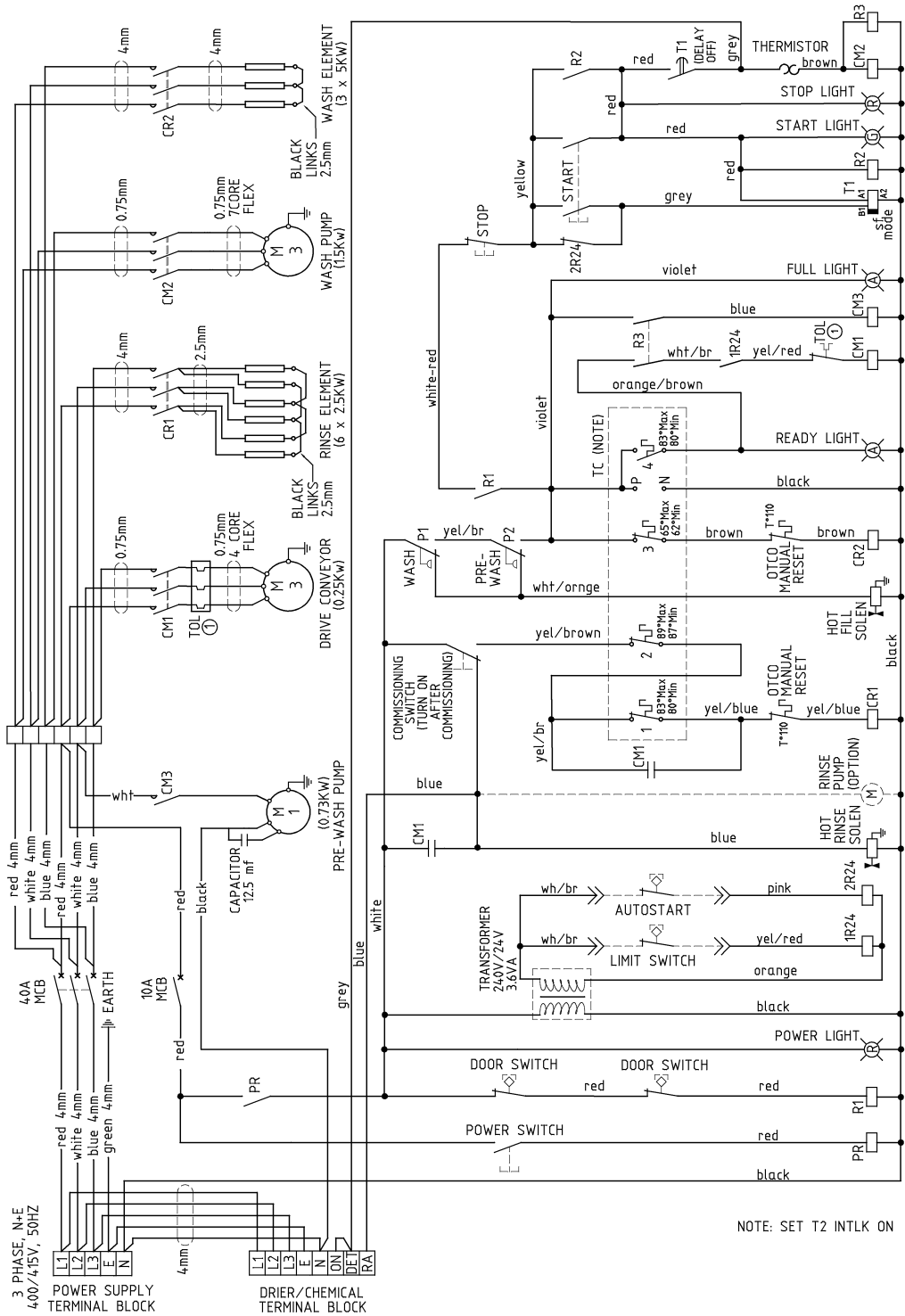



# Accessories

## CD180 Accessories

- Part #: CD180 ACW
- Date: 24-05-2022
- Version: 1-A

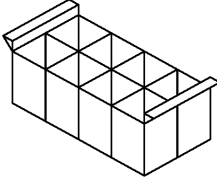

**C660508**  
**CUTLERY BASKET CP8 FOR 500mm**

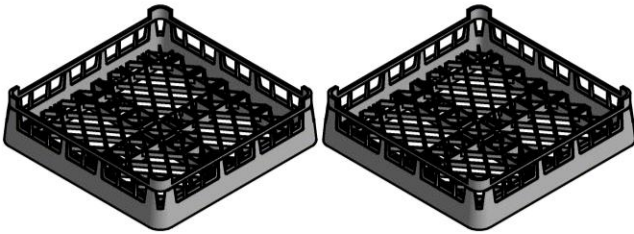

**600 70029**  
**2 x CUPRACK CB 500mm X 75mm high**

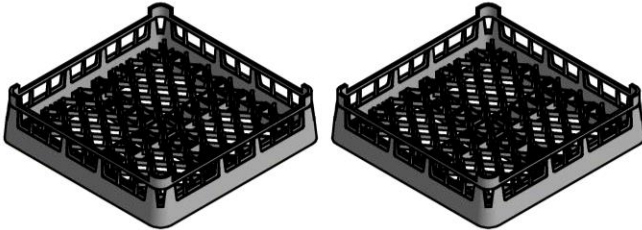

**600 70028**  
**2 x DISHRACK P12/18 500mm 18 DISH**

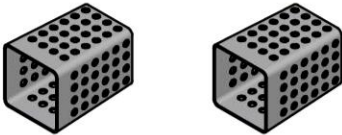

**C660503**  
**2 x CUTLERY CONTAINER G**

# Notes

# Notes

Information supplied in this manual is copyright. No part of this work may be reproduced or copied in any form or by any means, electronic or mechanical without the express permission of the author/publisher

Distributed in Australia by Moffat Pty Limited



740 Springvale Road  
Mulgrave 3170  
Victoria  
Australia

24HR Service 1300 264 217  
Parts 1300 263 107  
Tel 03 9518 3888  
Fax 03 9518 3818  
E-mail [sales@moffat.com.au](mailto:sales@moffat.com.au)  
web [www.moffat.com.au](http://www.moffat.com.au)

#### ISO9001

All Washtech products are designed and manufactured by Washtech using the internationally recognised ISO9001 quality management system, covering design, manufacture and final inspection, ensuring consistent high quality at all times.

In line with policy to continually develop and improve its products, Washtech Ltd reserves the right to change specifications and design without prior notice.

an Ali Group Company



The Spirit of Excellence